

Q3XTBLD50-Q8

Photoelectric Sensor – Laser Sensor

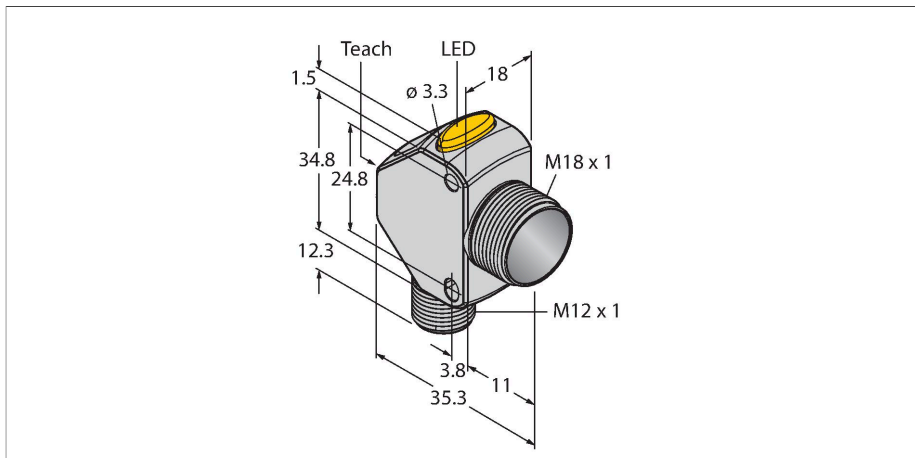

Technical data

Type	Q3XTBLD50-Q8
ID	3091629
Optical data	
Function	Proximity switch
Operating mode	Diffuse/Background suppression
Light type	Red
Wavelength	655 nm
Laser class	▲ 2
Range	0...50 mm
Ambient light immunity	> 5000 lux
Electrical data	
Operating voltage	10...30 VDC
DC rated operational current	≤ 28 mA
Short-circuit protection	yes
Reverse polarity protection	yes
Output function	NO/NC, PNP/NPN
Current output	100 mA
Readiness delay	≤ 1000 ms
Response time typical	< 0.25 ms
Setting option	Push Button Remote Teach
Mechanical data	
Design	Rectangular with thread, Q3X
Dimensions	Ø 18 x 35.3 x 18 x 48.6 mm
Housing material	Metal, Nickel-plated, Galvanized
Lens	acrylic, Acrylic
Electrical connection	Connector, M12 × 1, PVC

Features

- 3-digit 7-segment LED display
- 2 buttons
- Output indicator (yellow)
- IP67/69K
- Range: 0...50 mm
- Fixed background suppression at 60 mm
- Laser class 2, red, 655 nm, acc. to IEC 60825-1:2007
- Operating voltage: 10...30 VDC
- 1 × PNP, 1 × NPN switching output
- Rectangular model with offset M18 thread
- Die-cast zinc housing

Wiring diagram

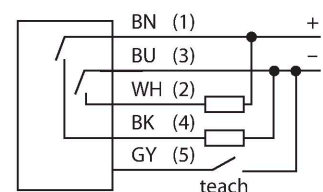

Functional principle

The Q3XTBLD50-Q8 sensor combines the functionality of a contrast scanner with a fixed background suppression. This methodology is unique in the market. The range of the laser-class-2 sensor is 0...50mm at a fixed background suppression of 60mm. The Q3X has two switching outputs (1 PNP and 1 NPN). In RUN mode you can change the switchpoint and teach the sensor. In SETUP mode, you can select teach, all standard operating parameters and also return to the factory defaults.

Technical data

Number of cores	5
Ambient temperature	-10...+50 °C
Storage temperature	-25...+75 °C
Relative humidity	35...95 %
Protection class	IP67 IP68 IP69
Special features	keep/defer Wash down
Switching state	LED, Yellow
Display	3-digit 7-segment LED display
Excess gain indication	LED
Tests/approvals	
Vibration resistance	MIL-STD-202G, Method 201A (10 to 60 Hz, 1.52 mm peak to peak amplitude, for 2 hours along the x, y and z-axis), sensor operating
Shock test	MIL-STD-202G, Method 213B Condition I (100G 6 x along the XYZ-axis, 18 impacts), sensor in operation
Approvals	CE, cULus

Excess Gain Curve

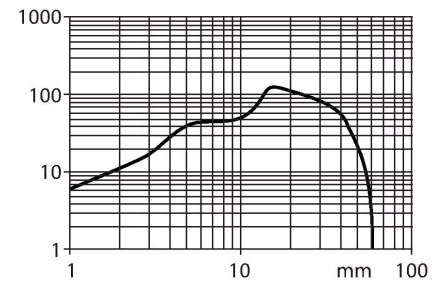

Accessories

SMBQ4XFAM10

3091513

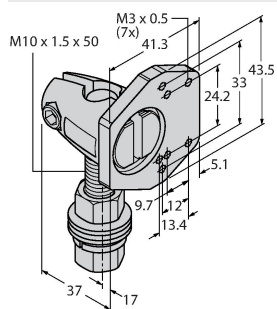

Mounting bracket, rotatable, stainless steel, for sensors of the Q4X/Q3X series, M10 x 1.5 thread

SMB18FAM10

3011184

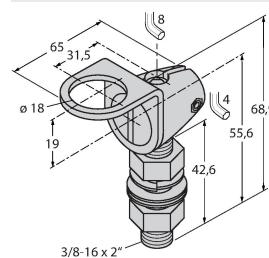

Mounting bracket, material VA 1.4401, for M10 x 1.5 thread, thread length 18 mm

SMB18A

3033200

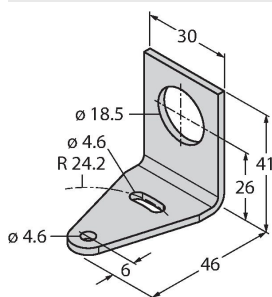

Mounting bracket, rectangular, stainless steel, for sensors with 18 mm thread

Accessories

Dimension drawing	Type	ID	
	RKC4.5T-2/TEL	6625016	Connection cable, female M12, straight, 5-pin, cable length: 2 m, sheath material: PVC, black; cULus approval; other cable lengths and qualities available, see www.turck.com
	RKH4.5-2/TFG	6933455	Connection cable, M12 female, straight, 5-pin, stainless steel coupling nut, cable length: 2 m, jacket material: TPE, gray, temperature range -40...+105 °C; other cable lengths and designs available, see www.turck.com
	WKC4.5T-2/TEL	6625028	Connection cable, female M12, angled, 5-pin, cable length: 2 m, sheath material: PVC, black; cULus approval; other cable lengths and qualities available, see www.turck.com