

SG-TL70-W

LED Indicator – Modular Signal Tower

Color Segment

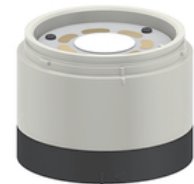
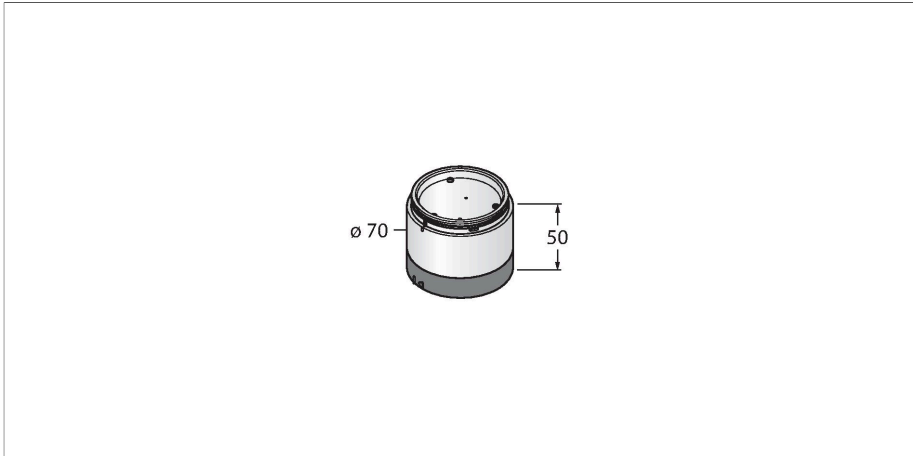

Technical data

Type	SG-TL70-W
ID	3092215
Signal and display data	
Purpose	LED indicator light
Function	Tower light
Light type	White
Color temperature	5000 K
Luminous flux lumen	125 lm
LED service life (L70)	50000 h
Dimmable	No
Features of color 1	White, Can be set via DIP switches, 125 lm
Electrical data	
Operating voltage	12...30 VDC
DC rated operational current	≤ 420 mA
Max. current consumption per color	420 mA
Response time typical	< 180 ms
Mechanical data	
Cascadable	No
Design	Smooth barrel, TL70
Dimensions	Ø 70 x 50 mm
Housing material	Plastic, PC, Black
Window material	Polycarbonate, diffuse
Ambient temperature	-40...+50 °C
Relative humidity	0...95 %
Protection class	IP65

Features

- Plastic housing, black
- Protection class IP65 (mounted)
- Monochrome: White
- Switchable between permanent and flashing function
- Operating voltage: 12...30 VDC
- Inputs: PNP/NPN

Functional principle

The rugged multifunction tower lights are available in many variations and are easily mounted. Each tower can be assembled of up to five color segments and, optionally, a beeper. All segments are configurable via DIP switches.

5 colors are available, blue (B), green (G), red (R), yellow (Y) and white (W), which can be used in any combination.

The arrangement of the segments can be modified subsequently and also more segments can be added. Via the basic module the respective port is selected.



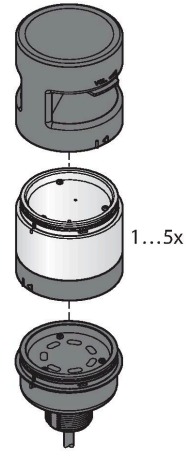

Technical data

Tests/approvals

Approvals CE, UL listed



Accessories

Dimension drawing	Type	ID	
	B-TL70-5	3092223	TL70 base module, black, cable, 5-pin, 2 m, connection of 4 segments possible
	B-TL70-8	3092224	TL70 base module, black, cable, 8-pin, 2 m, connection of 6 segments possible
	B-TL70-Q5	3092226	TL70 base module, black, connector, 5-pin, M12 x 1, connection of 4 segments possible
	B-TL70-Q8	3092227	TL70 base module, black, connector, 8-pin, M12 x 1, connection of 6 segments possible