

SG-TL70-A

LED Indicator – Modular Signal Tower

Audio Segment

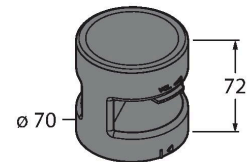
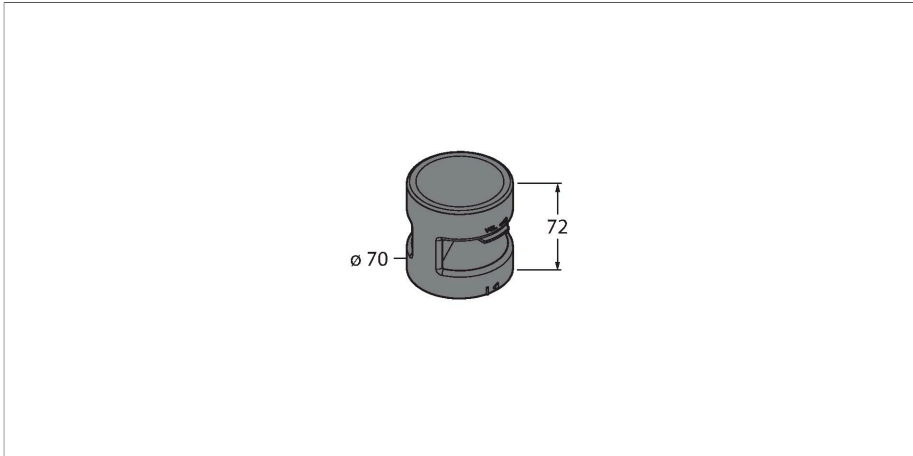

Technical data

Type	SG-TL70-A
ID	3092221
Signal and display data	
Purpose	LED indicator light
Function	Tower light
Dimmable	No
Acoustic signal	Key adjustable, 92 dB
Electrical data	
Operating voltage	12...30 VDC
DC rated operational current	≤ 30 mA
Max. current consumption of beeper	30 mA
Response time typical	< 180 ms
Mechanical data	
Cascadable	No
Design	Smooth barrel, TL70
Dimensions	Ø 70 x 72 mm
Housing material	Plastic, PC, Black
Window material	Polycarbonate, diffuse
Ambient temperature	-40...+50 °C
Relative humidity	0...95 %
Protection class	IP65
Tests/approvals	
Approvals	CE, UL listed

Features

- Plastic housing, black
- Protection class IP65 (mounted)
- Beeper, omnidirectional
- Configuration via DIP switch
- Operating voltage: 12...30 VDC
- Inputs: PNP/NPN

Functional principle



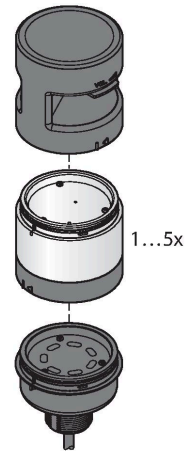

The rugged multifunction tower lights are available in many variations and are easily mounted. Each tower can be assembled of up to five color segments and, optionally, a beeper. All segments are configurable via DIP switches.

5 colors are available, blue (B), green (G), red (R), yellow (Y) and white (W), which can be used in any combination.

The arrangement of the segments can be modified subsequently and also more segments can be added. Via the basic module the respective port is selected.



Accessories

Dimension drawing	Type	ID	
	B-TL70-5	3092223	TL70 base module, black, cable, 5-pin, 2 m, connection of 4 segments possible
	B-TL70-8	3092224	TL70 base module, black, cable, 8-pin, 2 m, connection of 6 segments possible
	B-TL70-Q5	3092226	TL70 base module, black, connector, 5-pin, M12 x 1, connection of 4 segments possible
	B-TL70-Q8	3092227	TL70 base module, black, connector, 8-pin, M12 x 1, connection of 6 segments possible