

DF-G2IR-PS-Q7

Photoelectric Sensor – Photoelectric Sensor for Plastic Fibers

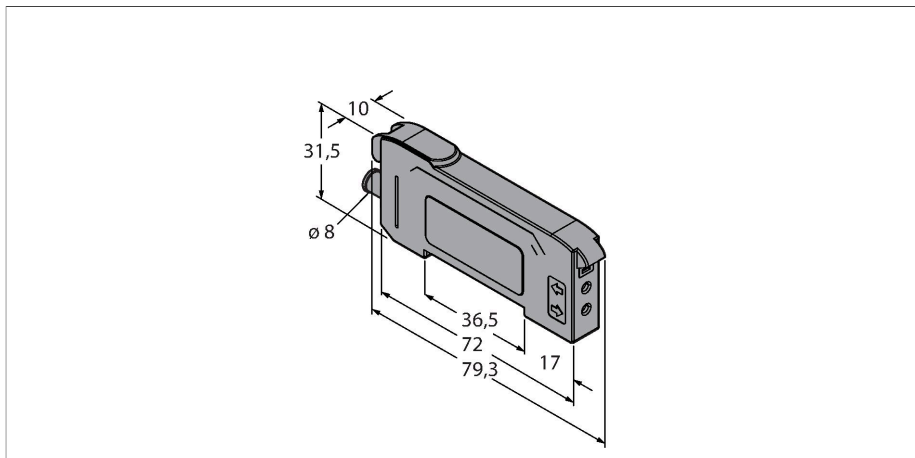

Technical data

Type	DF-G2IR-PS-Q7
ID	3092513
Optical data	
Function	Fiber optic sensor
Operating mode	Plastic fiber
Light type	IR
Wavelength	850 nm
Electrical data	
Operating voltage	10...30 VDC
Residual ripple	< 10 % U _{ss}
DC rated operational current	≤ 40 mA
Short-circuit protection	yes
Reverse polarity protection	yes
Output function	NO contact, PNP
Current output	100 mA
Switching frequency	50 kHz
Readiness delay	≤ 500 ms
Response time typical	< 0.01 ms
Setting option	Push Button Remote Teach
Mechanical data	
Design	Rectangular, DF-G1
Dimensions	79.3 x 10 x 33 mm
Housing material	Plastic, Thermoplastic material, Black
Electrical connection	Connector, M8 × 1, PVC
Number of cores	4
Ambient temperature	-10...+55 °C

Features

- Male connector, 8 mm, 4-pin
- Infrared emitter LED
- Programming via teach cable or multi-function button
- Operating voltage: 10...30 VDC
- PNP output
- Light/dark operation

Wiring diagram

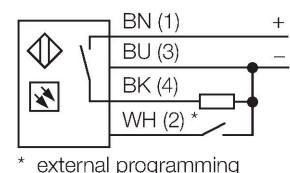

Functional principle

Glass or plastic fibers are the optimum choice for high-temperature applications and limited spaces. Optical fibers transfer the light from the sensor to a remote object. Single optical fibers are suited for opposed sensing mode, while bifurcated optical fibers are best suited for diffuse sensing mode.

Technical data

Relative humidity	0...90 %
Protection class	IP50
Special features	keep/defer
Switching state	LED, Yellow
Excess gain indication	Dual Digital Displays
Tests/approvals	
Approvals	CE, cULus listed

Accessories

Dimension drawing	Type	ID	
	PKG4S-2/TEL	6627370	Connection cable, female Ø M8, straight, 4-pin, snap-on type, cable length: 2 m, jacket material: PVC, black; cULus approval; other cable lengths and qualities available, see www.turck.com
	PKW4S-2/TEL	6627373	Connection cable, Ø 8 mm female, snap-on type, angled, 4-pin, cable length: 2 m, jacket material: PVC, black; cULus approval; other cable lengths and qualities available, see www.turck.com

Accessories

Dimension drawing	Type	ID	
	PBT16U	3042822	Plastic fiber-optic sensor, operating mode: Diffuse mode, threaded sleeve M3 x 0.75 mm, field wireable wire without end tip, polyethylene sheath, ambient temperatures -30 °C...+70 °C
	PBT26U	3026080	Plastic fiber, sensing mode: Diffuse mode, threaded bush M3 x 0.75 mm, preassembled wire without end tip, polyethylene jacket, ambient temperatures -30 °C...+70 °C

Dimension drawing	Type	ID	
	PBT46U	3025967	Plastic fiber-optic sensor, operating mode: Diffuse mode, threaded sleeve M3 x 0.75 mm, field wireable wire without end tip, polyethylene sheath, ambient temperatures -30 °C...+70 °C

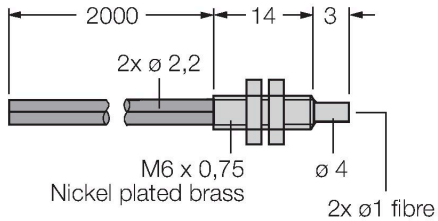

PBT66U	3039982
--------	---------

Plastic fiber-optic sensor, operating mode: Diffuse mode, threaded sleeve M6 x 0.75 mm, pre-assembled wire without end tip, polyethylene sheath, ambient temperatures -30 °C...+70 °C

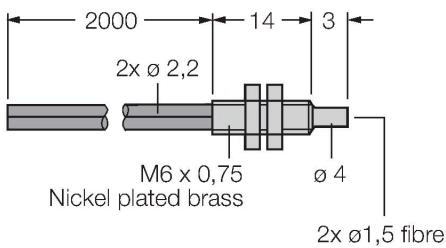

PIT16U	3039983
--------	---------

Plastic fiber-optic sensor, operating mode: Opposed mode, threaded sleeve M3 x 0.5 mm, field wireable wire without end tip, polyethylene sheath, ambient temperatures -30 °C...+70 °C

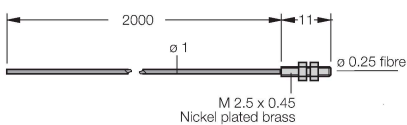

PIT26U	3026079
--------	---------

Plastic fiber, sensing mode: Opposed mode, threaded bush M3 x 0.5 mm, preassembled wire without end tip, polyethylene jacket, ambient temperatures -30 °C...+70 °C

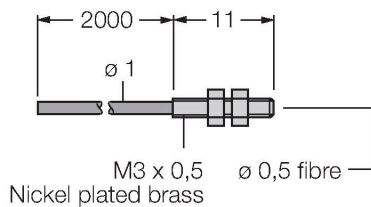

Dimension drawing	Type	ID	
	PIT46U	3026034	Plastic fiber-optic sensor, operating mode: Opposed mode, threaded sleeve M3 x 0.5 mm, field wireable wire without end tip, polyethylene sheath, ambient temperatures -30 °C...+70 °C

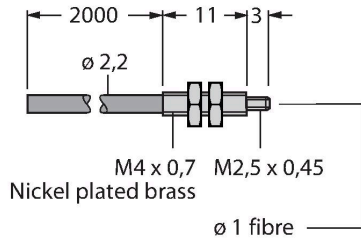

PIT66U	3039899
--------	---------

Plastic fiber-optic sensor, operating mode: Opposed mode, threaded sleeve M3 x 0.5 mm, field wireable wire without end tip, polyethylene sheath, ambient temperatures -30 °C...+70 °C

