

# WLB92X550PWM

## Work Light – Linear Light

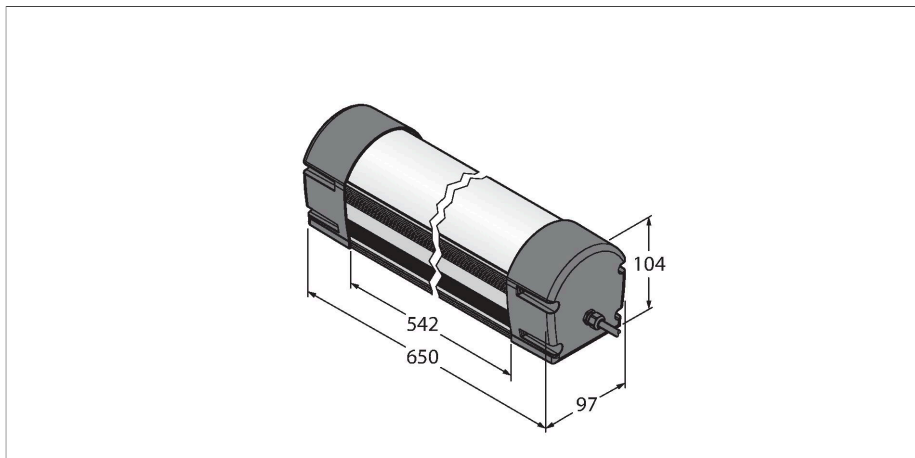

### Technical data

Type	WLB92X550PWM
ID	3093284
<b>Signal and display data</b>	
Purpose	LED work light
Function	Linear light
Light type	White
Color temperature	4700...+5300 K
Luminous flux lumen	3130 lm
Dimmable	PWM
Features of color 1	White, Permanently on, 3510 lm
<b>Electrical data</b>	
Operating voltage	21.6...26.4 VDC
DC rated operational current	≤ 1450 mA
<b>Mechanical data</b>	
Cascadable	No
Design	Rectangular, WLB92
Dimensions	665 x 97 x 104 mm
Housing material	Metal, AL, Anodized
Window material	Polycarbonate, diffuse
Electrical connection	Cable, 2 m, PVC
Number of cores	3
Ambient temperature	-40...+70 °C
Protection class	IP40
<b>Tests/approvals</b>	
Approvals	CE

### Features

- Light beam: 550mm
- Operating voltage: 24 VDC (±10%)
- Protection class: IP50
- Color: White
- Cable, 2 m
- External PWM signal for continuous dimming of the light output (0% - 100%) required

### Wiring diagram

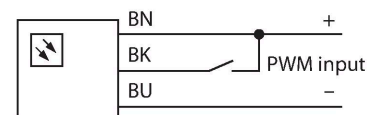

### Functional principle

The WLB92 LED linear light is designed for multi-purpose use, is powered by 24 VDC and convinces by its robust metal housing and shatter-proof window material. An external PWM signal is required for the continuous dimming of light output from 0% -100%. The color temperature lies in the range of daylight, between 5,000 and 10,000 Kelvin. With a lifetime of 50,000 hours and very energy efficient LEDs, this a cost-saving and environmentally friendly alternative to conventional fluorescent lamps. This linear light is available in two lengths and more than twice as bright as the known WLB32 LED light.

## Accessories

LMBWLB92

3093567

Snap bracket for WLB92 work light, included in the WLB92 scope of delivery

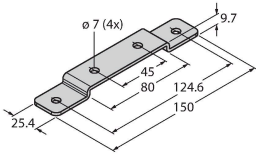

LMBWLB92CLIP

3093568

Snap bracket for WLB92 linear light

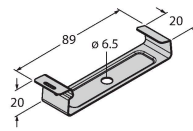

LMBWLB92HK5

3093569

Pendant mounting bracket for WLB92

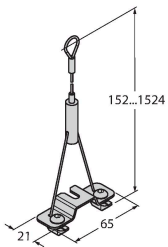

LMBWLB92S

3093570

Mounting bracket for front side mounting of the WLB92

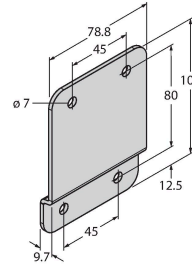

LMBWLB92RAS

3093571

Pivoting mounting bracket for WLB92 line light

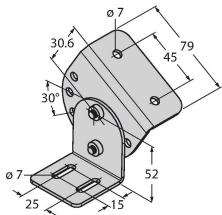

## Accessories

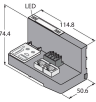
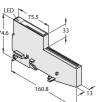
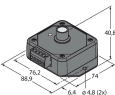
Dimension drawing	Type	ID	
	BL20-PG-EN-V3	6827393	CODESYS 3 programmable gateway for connecting BL20 I/Os to PROFINET, EtherNet/IP and Modbus TCP master
	BL20-E-2CNT-2PWM	6827341	2 counters 200kHz, 2 PWM 20kHz
	LC65P1T	3088188	LED dimmer module, for stepless dimming of the light output for PWM-capable LED lights