

# LTF12IC2LDQ

## Photoelectric Sensor – Laser Scanning System

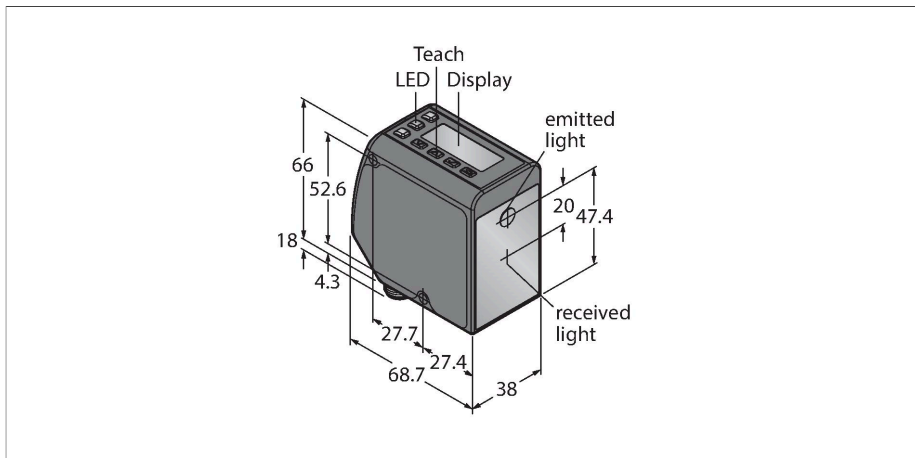

### Technical data

Type	LTF12IC2LDQ
ID	3094849
<b>Optical data</b>	
Function	Proximity switch
Operating mode	Time-of-Flight
Light type	Red
Wavelength	660 nm
Laser class	▲ 2
Optical resolution	3 mm
Repeatability	1.5 mm
Range	50...12000 mm
Ambient light immunity	40000 lux
<b>Electrical data</b>	
Operating voltage	12...30 VDC
DC rated operational current	≤ 85 mA
Short-circuit protection	yes
Reverse polarity protection	yes
Output function	NO contact, PNP/NPN
Output 2	Analog output
Type of analog output	4...20 mA
Current output	4...20 mA
Switching frequency	≤ 250 Hz
Readiness delay	≤ 2 s
Readiness delay	≤ 2000 ms
Response time typical	< 1.5 ms
<b>Mechanical data</b>	
Design	Rectangular, LTF

### Features

- 2-line, 8-segment display
- M12 × 1 male connector, rotatable, 5-pin
- Range: 0.05...12 m
- Laser class 2, red, 660 nm, acc. to IEC 60825-1:2007
- Resolution: 0.3...3 mm
- Operating voltage: 12...30 VDC
- PNP/NPN-switching output, switchable
- Analog output: 4...20 mA

### Wiring diagram

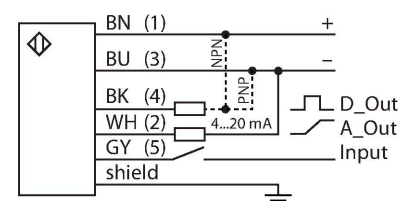

### Functional principle

The LTF laser sensors measure the distance to an object up to a range of 12 m. The settings are made via buttons on the housing. The built-in display assists with the menu navigation and serves to display the measured distance. The switching output is re-programmable and the analog output is, depending on the type, either laid out as current or voltage output. The integrated connector is rotatable by 90° degrees which makes it easy to mount. The transmitter LED can be turned off via the menu or the gray wire (PIN 5). The same wire can be used to operate two devices in the synch mode, which prevents mutual influence. The measuring accuracy can be obtained from the excess gain curve.

## Technical data

Dimensions	77 x 26 x 56 mm
Housing material	Metal, Zinc Alloy Die-Cast, Black
Lens	plastic, Polycarbonate
Electrical connection	Connector, M12 × 1, PVC
Number of cores	5
Ambient temperature	-20...+55 °C
Storage temperature	-30...+65 °C
Relative humidity	90 %
Protection class	IP67
Special features	keep/defer
Power-on indication	LED, Green
Switching state	LED, Yellow
<b>Tests/approvals</b>	
Vibration resistance	acc. to IEC 60947-5-2
Shock test	acc. to IEC 60947-5-2
Approvals	CE

## Excess Gain Curve

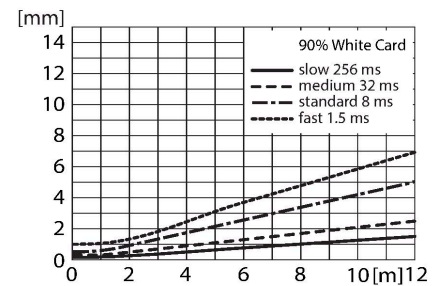

## Accessories

SMBLTFU

3094757

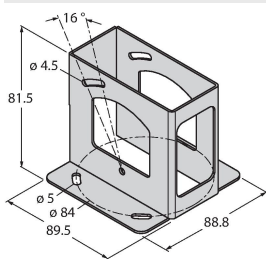

Protective housing, stainless steel, for sensors of the LTF series

SMBLTFL

3094756

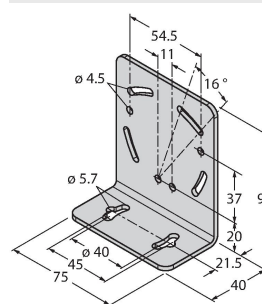

Mounting bracket, rectangular, stainless steel, for sensors of the LTF series

## Accessories

Dimension drawing	Type	ID	
<p>Technical drawing of the connection cable RKC4.5T-2/TEL. It shows a female M12 connector with a 14-pin configuration and a 5-pin cable. Dimensions include a connector diameter of 15 mm, a connector length of 11.5 mm, and a cable length of 42 mm.</p>	RKC4.5T-2/TEL	6625016	Connection cable, female M12, straight, 5-pin, cable length: 2 m, sheath material: PVC, black; cULus approval; other cable lengths and qualities available, see <a href="http://www.turck.com">www.turck.com</a>
<p>Technical drawing of the connection cable WKC4.5T-2/TEL. It shows a female M12 connector with a 14-pin configuration and a 5-pin cable. Dimensions include a connector diameter of 15 mm, a connector length of 26.5 mm, and a cable length of 32 mm.</p>	WKC4.5T-2/TEL	6625028	Connection cable, female M12, angled, 5-pin, cable length: 2 m, sheath material: PVC, black; cULus approval; other cable lengths and qualities available, see <a href="http://www.turck.com">www.turck.com</a>

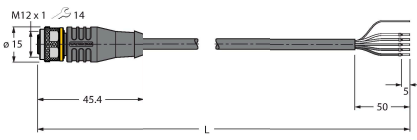
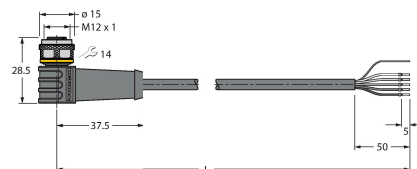
Dimension drawing	Type	ID	
	RKS4.5T-2/TEL	6626361	Connection cable, M12 female connector, straight, 5-pin, cable length: 2 m, sheath material: PVC, black; shielded; cULus approval; other cable lengths and qualities available, see <a href="http://www.turck.com">www.turck.com</a>
	WKS4.5T-2/TEL	6626364	Connection cable, M12 female connector, angled, 5-pin, cable length: 2 m, sheath material: PVC, black; shielded; cULus approval; other cable lengths and qualities available, see <a href="http://www.turck.com">www.turck.com</a>