

WLS27XW570DSPWMQ

Work Light – Linear Light



Features

- Cylindrical illuminated area
- Operating voltage: 12...30 VDC
- Protection class IP67/IP69K
- M12 × 1 male connector, straight, 4-pin
- Light length L1: 570 mm
- Housing length L2: 633.5 mm
- Color: White
- M12 × 1 male, straight, 4-pin
- Dimmable via PWM input
- FDA compliant
- 2 × LMBWLS27EC snap bracket included in delivery

Wiring diagram

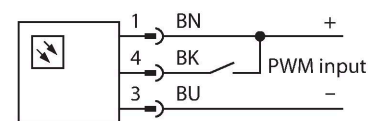

Functional principle

The energy-efficient LED work lights are ideally suited for industrial applications. The color temperature is between 6,000 and 7,100 Kelvin (cool white). Depending on the model, the luminous flux is 325 or 2600 lumen. The device is switched on/off upon application of power (12...30 VDC). In addition, the light can be dimmed to 50% of its power by triggering a high signal on PIN 4. When using 2-color variants, it is switched between the colors. On some models the light output is continuously dimmable via a PWM signal on pin 4. Cascadable variants are also available. Available colors are cold white, warm white, green, red, yellow and blue.

Technical data

Type	WLS27XW570DSPWMQ
ID	3095864
Signal and display data	
Purpose	LED work light
Function	Linear light
Light type	White
Color temperature	6100...+7000 K
Luminous flux lumen	1300 lm
LED service life (L70)	50000 h
Dimmable	PWM
Features of color 1	White, Permanently on, 1600 lm
Special features	Chemical-resistant Wash down Resistant to chemicals
Electrical data	
Operating voltage	12...30 VDC
Max. current consumption per color	1600 mA
Input power	14.64 W
Mechanical data	
Cascadable	No
Design	Smooth barrel, WLS27
Dimensions	Ø 27 x 633.5 mm
Housing material	Plastic, FDA copolyester
Window material	Copolyester, diffuse
Electrical connection	Connector, M12 × 1, PVC
Number of cores	4
Ambient temperature	-40...+70 °C

Technical data



Storage temperature	-40...+70 °C
Protection class	IP66 IP67 IP69
Protection class for electrical equipment	III
Tests/approvals	

Light Length	Typical Current			Max. Current
	12 VDC	24 VDC	30 VDC	A
145 mm	0.33 A	0.15 A	0.12 A	0.4
285 mm	0.66 A	0.30 A	0.24 A	0.8
430 mm	1.01 A	0.46 A	0.36 A	1.2
570 mm	1.36 A	0.61 A	0.48 A	1.6
710 mm	1.75 A	0.77 A	0.60 A	2.0
850 mm	2.13 A	0.92 A	0.73 A	2.4
990 mm	2.59 A	1.08 A	0.85 A	2.8
1130 mm	3.04 A	1.24 A	0.97 A	3.2

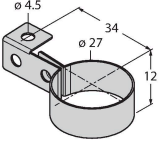
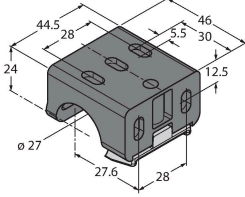
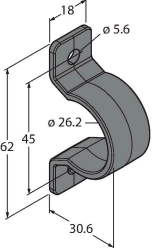
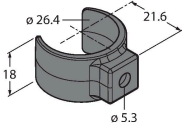
Accessories

LMBWLS27H	3094776	LMBWLS27U	3094775
Hanging bracket for WLS27		Universal mounting bracket for WLS27	
			
LMBWLS27EC	3094774	LMBWLS27SP	3094773
Snap bracket for WLS27		Snap bracket for WLS27	
			

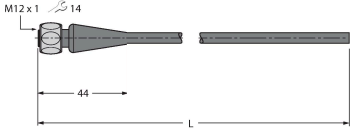
Accessories

Dimension drawing	Type	ID	
	RKH4.5-2/TFG	6933455	Connection cable, M12 female connector, straight, 5-pin, stainless steel coupling nut, cable length: 2 m, jacket material: TPE, gray; temperature range: -40...+105 °C
	RKC4.4T-2/TEL	6625013	Connection cable, M12 female connector, straight, 4-pin, cable length: 2 m, jacket material: PVC, black; cULus approval

Dimension drawing

Type

WKC4.4T-2/TEL

ID

6625025

Connection cable, M12 female connector, angled, 4-pin, cable length: 2 m, jacket material: PVC, black; cULus approval

