

BI5U-M18M-AD4X-H1144

Inductive Sensor

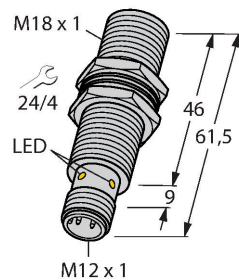

Features

- Threaded barrel, M18 x 1
- Chrome-plated brass
- Factor 1 for all metals
- Resistant to magnetic fields
- DC 2-wire, 10...65 VDC
- NO contact
- M12 x 1 male connector

Technical data

Type	BI5U-M18M-AD4X-H1144
ID	4405066
General data	
Rated switching distance	5 mm
Mounting conditions	Flush
Secured operating distance	$\leq (0.81 \times S_n)$ mm
Repeat accuracy	≤ 2 % of full scale
Temperature drift	$\leq \pm 10$ %
	$\leq \pm 15$ %, ≤ -25 °C \vee $\geq +70$ °C
Hysteresis	3...20 %
Electrical data	
Operating voltage	10...65 VDC
Residual ripple	≤ 10 % U_{ss}
DC rated operational current	≤ 100 mA
Residual current	≤ 0.8 mA
Isolation test voltage	≤ 0.5 kV
Short-circuit protection	yes / Cyclic
Voltage drop at I_o	≤ 5 V
Wire breakage/Reverse polarity protection	Complete
Output function	2-wire, NO contact, 2-wire
DC field stability	300 mT
AC field stability	300 mT _{ss}
Smallest operating current	≥ 3 mA
Switching frequency	0.01 kHz
Mechanical data	
Design	Threaded barrel, M18 x 1

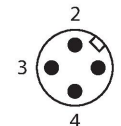
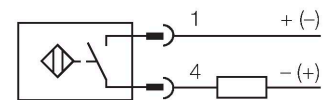

Functional principle

Inductive sensors are designed for wear-free and contactless detection of metal objects. uprox+ sensors have significant advantages due to their patented multi-coil system. They excel thanks to their optimum switching distances, maximum flexibility and operational reliability as well as efficient standardization.

Technical data

Dimensions	61.5 mm
Housing material	Metal, CuZn, Chrome-plated
Active area material	Plastic, LCP
Connector housing	plastic, PP
Max. tightening torque of housing nut	25 Nm
Electrical connection	Connector, M12 × 1
Environmental conditions	
Ambient temperature	-25...+70 °C
Vibration resistance	55 Hz (1 mm)
Shock resistance	30 g (11 ms)
Protection class	IP68
MTTF	874 years acc. to SN 29500 (Ed. 99) 40 °C
Switching state	LED, Yellow

Mounting instructions

Mounting instructions/Description

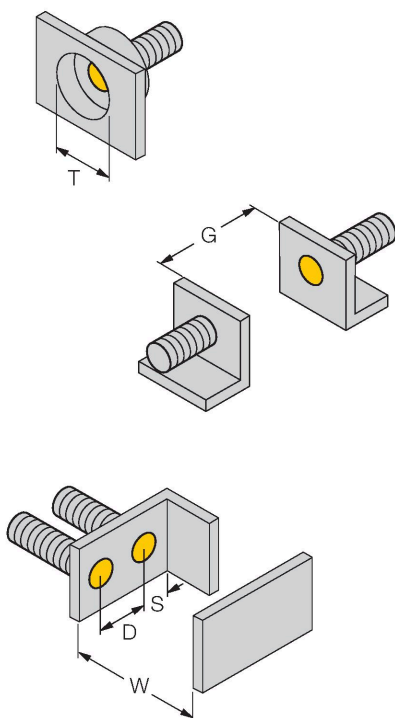

Distance D	36 mm
Distance W	3 x Sn
Distance T	3 x B
Distance S	1.5 x B
Distance G	6 x Sn
Diameter active area B	Ø 18 mm

All flush mountable uprox+ threaded barrel types are also recessed mountable. Safe operation is ensured if the sensor is screwed in by half a turn.

Accessories

BL20-4DI-NAMUR

6827212

4 digital inputs acc. to EN 60947-5-6
For NAMUR sensors, de-energized contacts or uprox®+ 2-wire DC sensors.

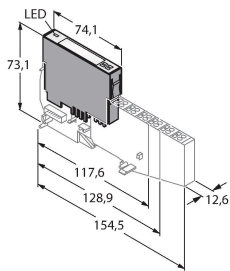

MW-18

6945004

Mounting bracket for threaded barrel sensors; material: Stainless steel A2 1.4301 (AISI 304)

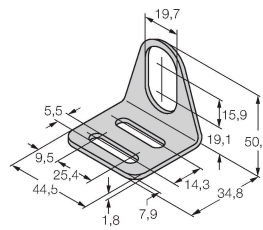

BSS-18

6901320

Mounting clamp for smooth and threaded barrel sensors; material: Polypropylene

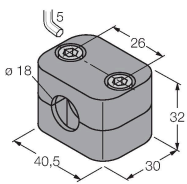

QM-18

6945102

Quick-mount bracket with dead-stop; material: Chrome-plated brass. Male thread M24 × 1.5. Note: The switching distance of the proximity switches may change when using quick-mount brackets.

