

# BI2-EG08-AG41X

## Inductive Sensor – With Increased Switching Distance

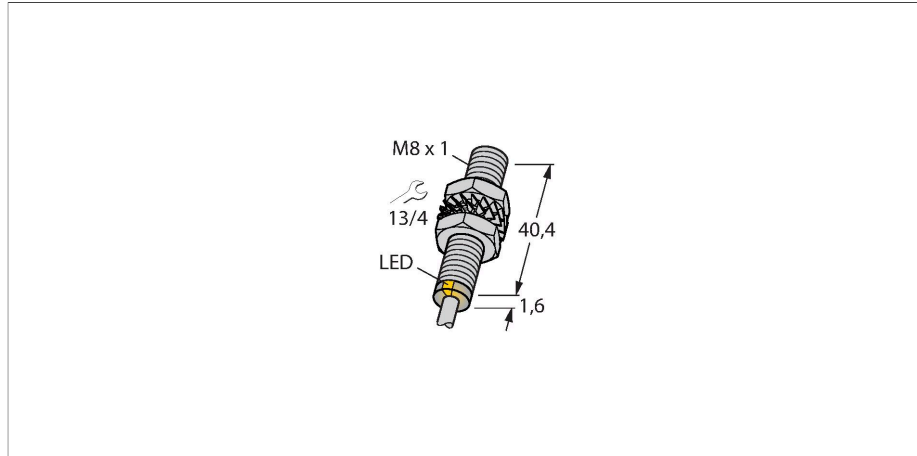

### Features

- Threaded barrel, M8 x 1
- Stainless steel, 1.4427 SO
- Large sensing range
- DC 2-wire, 10...55 VDC
- Polarized version
- NO contact
- Cable connection

### Wiring diagram

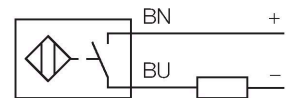

### Technical data

Type	BI2-EG08-AG41X
ID	4562000
<b>General data</b>	
Rated switching distance	2 mm
Mounting conditions	Flush
Secured operating distance	$\leq (0.81 \times S_n)$ mm
Correction factors	St37 = 1; Al = 0.3; stainless steel = 0.7; Ms = 0.4
Repeat accuracy	$\leq 2$ % of full scale
Temperature drift	$\leq \pm 10$ %
Hysteresis	1...15 %
<b>Electrical data</b>	
Operating voltage	10...55 VDC
Residual ripple	$\leq 10$ % $U_{ss}$
DC rated operational current	$\leq 100$ mA
Residual current	$\leq 0.6$ mA
Isolation test voltage	$\leq 0.5$ kV
Short-circuit protection	yes / Cyclic
Voltage drop at $I_o$	$\leq 3.5$ V
Wire breakage/Reverse polarity protection	Polarized
Output function	NO contact, 2-wire
Smallest operating current	$\geq 3$ mA
Switching frequency	0.3 kHz
<b>Mechanical data</b>	
Design	Threaded barrel, M8 x 1
Dimensions	42 mm
Housing material	Stainless steel, 1.4427 SO

### Functional principle

Inductive sensors detect metal objects contactless and wear-free. For this, they use a high-frequency electromagnetic AC field that interacts with the target. Inductive sensors generate this field via an RLC circuit with a ferrite coil.

## Technical data

Active area material	Plastic, PA12-GF30
End cap	Plastic, PA12-GF30
Max. tightening torque of housing nut	5 Nm
Electrical connection	Cable
Cable quality	Ø 4 mm, LifYY-11Y, PUR, 2 m
Core cross-section	2 x 0.25 mm <sup>2</sup>
<b>Environmental conditions</b>	
Ambient temperature	-25...+70 °C
Vibration resistance	55 Hz (1 mm)
Shock resistance	30 g (11 ms)
Protection class	IP67
MTTF	2283 years acc. to SN 29500 (Ed. 99) 40 °C
Switching state	LED, Yellow

## Mounting instructions

### Mounting instructions/Description



Distance D	2 x B
Distance W	3 x Sn
Distance T	3 x B
Distance S	1.5 x B
Distance G	6 x Sn
Diameter active area B	Ø 8 mm

## Accessories

**QM-08** **6945100**

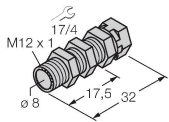

Quick-mount bracket with dead-stop, chrome-plated brass, male thread M12 x 1. Note: The switching distance of proximity switches may be reduced through the use of quick-mount brackets.

**BST-08B** **6947210**

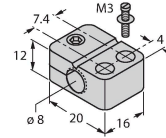

Mounting clamp for threaded barrel sensors, with dead-stop; material: PA6

**MW-08** **6945008**

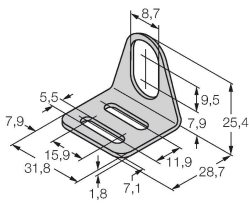

Mounting bracket for threaded barrel sensors; material: Stainless steel A2 1.4301 (AISI 304)

**BSS-08** **6901322**

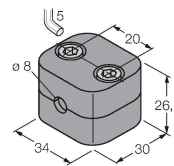

Mounting clamp for smooth and threaded barrel sensors; material: Polypropylene

**MBS80** **69479**

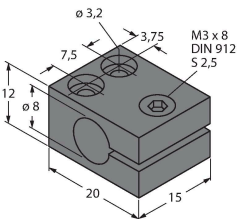

Mounting clamp for smooth barrel sensors; mounting block material: Anodized aluminum