

# NI15-S30-AP6X-H1141

## Inductive Sensor

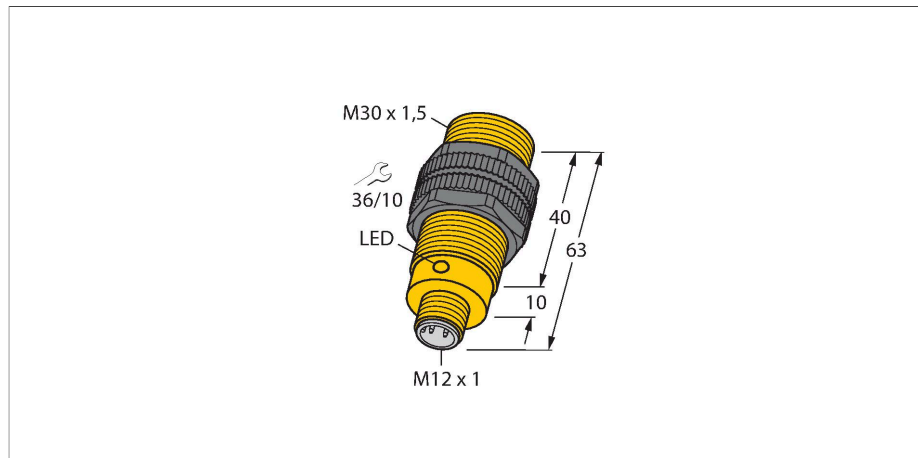

### Features

- Threaded barrel, M30 x 1.5
- Plastic, PA12-GF30
- DC 3-wire, 10...30 VDC
- NO contact, PNP output
- M12 x 1 male connector

### Wiring diagram

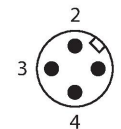
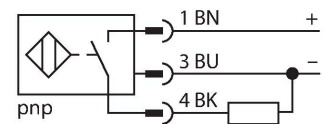

### Technical data

Type	NI15-S30-AP6X-H1141
ID	46582
<b>General data</b>	
Rated switching distance	15 mm
Mounting conditions	Non-flush
Secured operating distance	$\leq (0.81 \times S_n)$ mm
Correction factors	St37 = 1; Al = 0.3; stainless steel = 0.7; Ms = 0.4
Repeat accuracy	$\leq 2$ % of full scale
Temperature drift	$\leq \pm 10$ %
Hysteresis	3...15 %
<b>Electrical data</b>	
Operating voltage	10...30 VDC
Residual ripple	$\leq 10$ % $U_{ss}$
DC rated operational current	$\leq 200$ mA
No-load current	15 mA
Residual current	$\leq 0.1$ mA
Isolation test voltage	$\leq 0.5$ kV
Short-circuit protection	yes / Cyclic
Voltage drop at $I_o$	$\leq 1.8$ V
Wire breakage/Reverse polarity protection	yes / Complete
Output function	3-wire, NO contact, PNP
Switching frequency	0.5 kHz
<b>Mechanical data</b>	
Design	Threaded barrel, M30 x 1.5
Dimensions	63 mm
Housing material	Plastic, PA12-GF30

### Functional principle

Inductive sensors detect metal objects contactless and wear-free. For this, they use a high-frequency electromagnetic AC field that interacts with the target. Inductive sensors generate this field via an RLC circuit with a ferrite coil.

## Technical data

Active area material	Plastic, PA12-GF30
Max. tightening torque of housing nut	5 Nm
Electrical connection	Connector, M12 × 1
<b>Environmental conditions</b>	
Ambient temperature	-25...+70 °C
Vibration resistance	55 Hz (1 mm)
Shock resistance	30 g (11 ms)
Protection class	IP67
MTTF	2283 years acc. to SN 29500 (Ed. 99) 40 °C
Switching state	LED, Yellow

## Mounting instructions

### Mounting instructions/Description



Distance D	3 x B
Distance W	3 x Sn
Distance T	3 x B
Distance S	1.5 x B
Distance G	6 x Sn
Distance N	2 x Sn
Diameter active area B	Ø 30 mm

## Accessories

QM-30

6945103

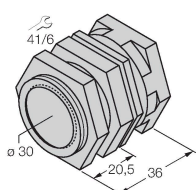

Quick-mount bracket with dead-stop; material: Chrome-plated brass. Male thread M36 × 1.5. Note: The switching distance of the proximity switches may change when using quick-mount brackets.

BST-30B

6947216

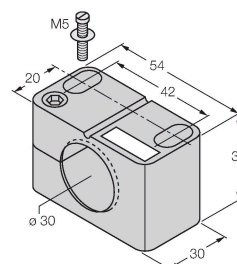

Mounting clamp for threaded barrel sensors, with dead-stop; material: PA6

MW-30

6945005

Mounting bracket for threaded barrel sensors; material: Stainless steel A2 1.4301 (AISI 304)

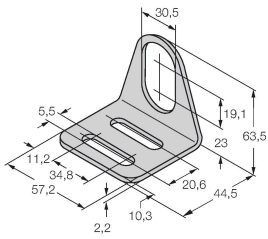

BSS-30

6901319

Mounting clamp for smooth and threaded barrel sensors; material: Polypropylene

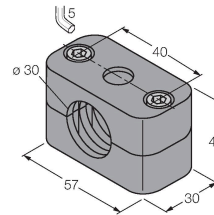

## Accessories

Dimension drawing	Type	ID	
	RKC4T-2/TEL	6625010	Connection cable, M12 female connector, straight, 3-pin, cable length: 2 m, jacket material: PVC, black; cULus approval

