

# RSSD-RSSD-4414-2M

## Industrial Ethernet Cable – Extension Cable

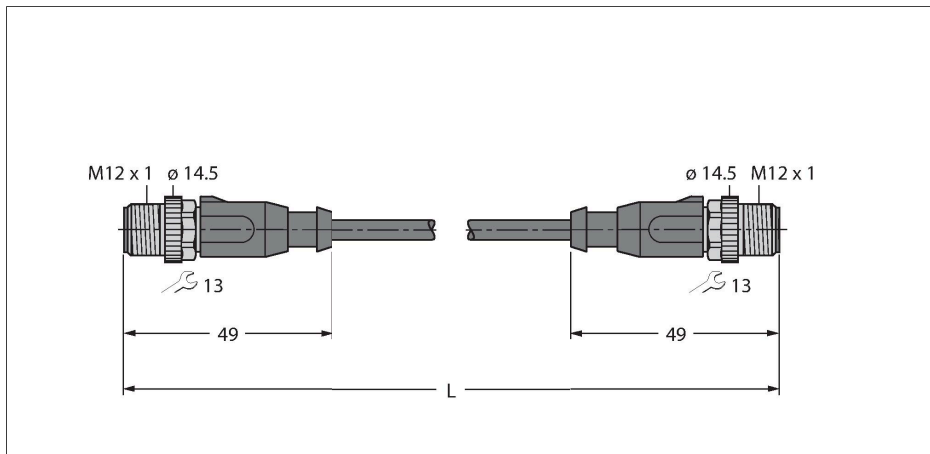

### Technical data

Type	RSSD-RSSD-4414-2M
ID	6441405
Connector A	Male, M12 × 1, Straight, D-coded
Number of Pins	4
Contacts	Metal, CuZn, Gold-plated
Contact carriers	Plastic, PA, UL 94, Black
Connector body	Plastic, TPU, UL 94, Black
Coupling nut/screw	Brass, GD-Zn, Nickel-plated
Tightening torque (range)	0.4 ... 0.6 Nm (observe max. torque of mating connector!)
Mechanical lifespan	> 100 Mating cycles
Pollution degree	3/2
Protection class	IP67, Only in screwed condition
Connector B	Male, M12 × 1, Straight, D-coded
Number of pins	4
Contacts	Metal, CuZn, Gold-plated
Contact carriers	Plastic, PA, UL 94, Black
Connector body	Plastic, TPU, UL 94, Black
Coupling nut/retaining screw	Brass, GD-Zn, Nickel-plated
Tightening torque	0.4 ... 0.6 Nm (observe max. torque of mating connector!)
Mechanical life	> 100 Mating cycles
Pollution degree	3/2
Protection class	IP67, Only when screwed together
Cable	
Network protocol	Ethernet, 4414
Cable diameter	Ø 4.8 mm ±0.30

### Features



- M12 male connector, straight, D-coded
- M12 male, straight, D-coded
- Ethernet cable: 4-pin, AWG 26
- CAT 5E acc. to ISO/IEC 11801, EN 50173, EIA/TIA 568-A
- Jacket material: PUR
- Jacket color: green
- Shielding: Aluminum-laminated polyester film, copper braid
- Jacket diameter: 4.8 mm
- Suitable for drag chain use
- UV resistant
- Oil resistant acc. to IEC 60811-2-1 and DIN VDE 0282 part 10
- Free from silicone, PVC and LABS
- Flame retardant acc. to IEC 60332-1-2
- Approval: cULus
- RoHS compliant
- Protection class IP67
- Cable length: 2.0 m

### Cable Cross-Section

## Technical data

Cable length	2 m
Cable jacket	PUR, Green
Shielding	Aluminum foil, tinned copper wire
Core insulation	PP
Core cross-section	4 x 0.15 mm <sup>2</sup>
Arrangement of strands	19 x 0.102 mm
Core colors	WHOG, WHBU, BU, OG
<b>Electrical properties at +20 °C</b>	
Rated voltage	42 V
Test voltage	700 V
Current	3 A
Nom. impedance	100 Ω (1MHZ)
Nom. capacitance	51 pF/m
<b>Mechanical and chemical properties</b>	
Bending radius (stationary installation)	≥ 15 x Ø
Bending cycles	≥ 5 million
Torsional stress	± 30 °/m
Torsion cycles	≤ 100,000 Cycles
Ambient temperature range (stationary)	-40...+80 °C
Ambient temperature range (In motion)	-25...+80 °C
<b>Other Features</b>	
Qualified for drag chain use	yes
Halogen-free	yes
Silicone-free	yes
PVC-free	yes
Resistant to weld splatter	yes
Resistant to chemicals	yes
UV resistance	yes
Oil-resistant	yes
Flame-retardant	yes
Approvals	cULus

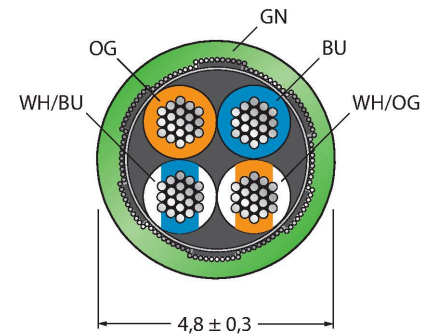

## Contact assignment

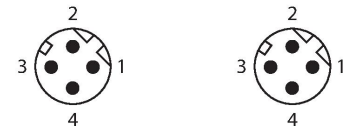

## Circuit Diagram

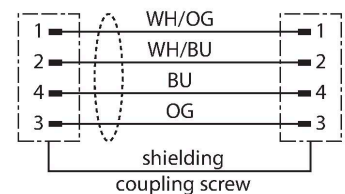

## Accessories

TORQUE-WRENCH-SET-BUS	6936171
Torque wrench set; grip with adjustable torque 0.4 to 1.0 Nm; torque wrench set, fork wrench for M8 (SW9), fork wrench for M12 (SW13), fork wrench for M12 (SW14)	