

# RKC4.5T-5-RSC4.5T/TRL

## Actuator and Sensor Cable Suitable for Use with Robots – Extension Cable

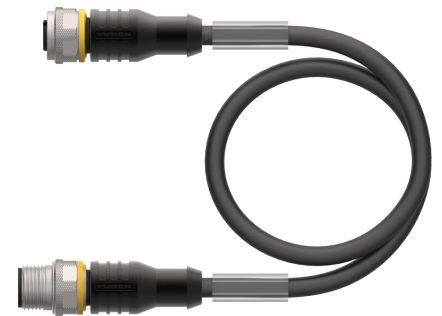
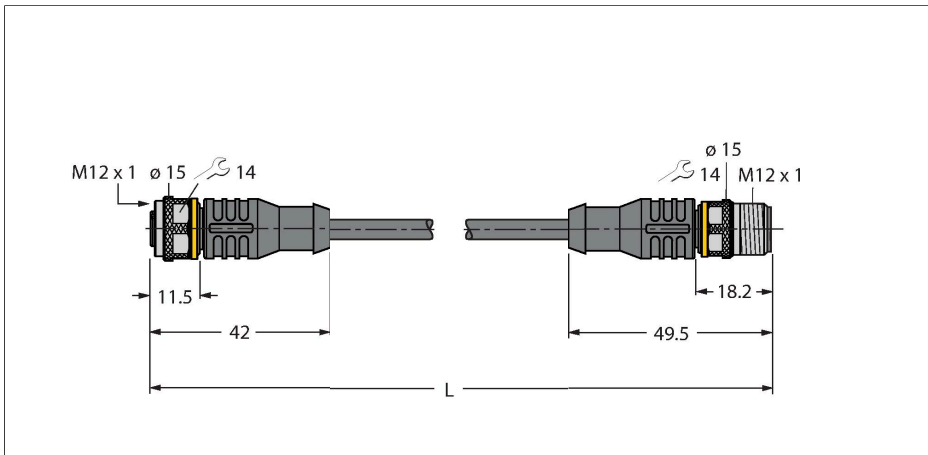

### Technical data

Type	RKC4.5T-5-RSC4.5T/TRL
ID	6543098
Connector A	Female, M12 × 1, Straight, A-coded
Number of Pins	5
Contacts	Brass, CuZn, Gold-plated
Contact carriers	Plastic, TPU, Black
Connector body	Plastic, TPU, Black
Coupling nut/screw	Brass, CuZn, Nickel-plated
Seal	Plastic, FPM/FKM
Mechanical lifespan	> 100 Mating cycles
Pollution degree	3
Protection class	IP67, IP69K, Only in screwed condition
Connector B	Male, M12 × 1, Straight, A-coded
Number of pins	5
Contacts	Brass, CuZn, Gold-plated
Contact carriers	Plastic, TPU, Black
Connector body	Plastic, TPU, Black
Coupling nut/retaining screw	Brass, CuZn, Nickel-plated
Mechanical life	> 100 Mating cycles
Pollution degree	3
Protection class	IP67, IP69K, Only when screwed together
Cable	
Cable diameter	Ø 4.8 mm ±0.20
Cable length	5 m
Cable jacket	PUR, Black

### Features



- Female M12, straight, 5-pin
- Male M12, straight, 5-pin
- Jacket material: PUR
- Jacket color: black
- Torsion resistant ( $\pm 360^\circ/m$ )
- Resistant to chemicals, UV radiation and oils
- Free from halogen, silicone, PVC and LABS
- Flame retardant
- Resistant to hydrolysis and microbes
- Protection class: IP67, IP69K
- Cable length: 5.0 m

### Cable Cross-Section

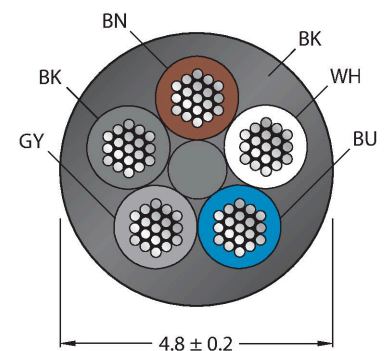

### Contact assignment

## Technical data

Core insulation	PP
Core cross-section	5 x 0.34 mm <sup>2</sup>
Arrangement of strands	42 x 0.1 mm
Core colors	BN, WH, BU, BK, GY
<b>Electrical properties at +20 °C</b>	
Rated voltage	60 V
Test voltage	2000 V
Current	4 A
<b>Mechanical and chemical properties</b>	
Bending radius (stationary installation)	≥ 5 x Ø
Bending radius (flexible use)	≥ 10 x Ø
Torsional stress	± 360 °/m
Torsion cycles	Max. 5 million
Torsion speed	20 Cycles/min
Ambient temperature (fixed)	-50...+80 °C
Ambient temperature (mobile)	-25...+80 °C
Halogen-free	Acc. to IEC 60754-1-2
LABS free	Acc. to PV3.10.7
Oil-resistant	Acc. to EN 60811-2-1
Flame-retardant	Acc. to IEC 60332-2-2, FT2
Approvals	cULus CE UKCA



## Circuit Diagram



## Accessories

<b>TORQUE-WRENCH-SET-AS</b>	6936170
Torque wrench set; handles with adjustable torque 0.4-1.0 Nm, torque wrench for M8 (SW9), fork wrench for M12 (SW 14)	

<b>BLANK-LABEL-FOR-CORDSETS-TEL-TXL</b>	6936206
Label for TEL and TXL cables, length: 18 mm, height: 4 mm, material: polycarbonate (PC), color: white, halogen-free and flame-retardant	

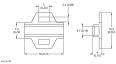

## Accessories

Dimension drawing	Type	ID	
	LABEL-HOLDER-FLEX-PVC	100048170	PVC label holder for identification of extension cables (TEL/TXL product series); for cable diameters: min. 5 mm; dimensions 4 x 18 mm; delivery unit: 50 pcs. per package