

PSG4M-5/TRL

Actuator and Sensor Cable Suitable for Use with Robots – Connection Cable

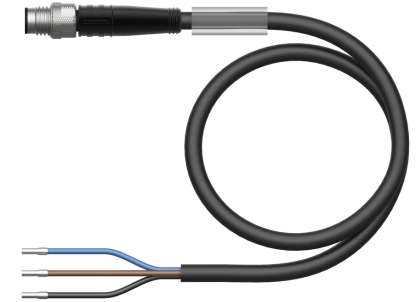
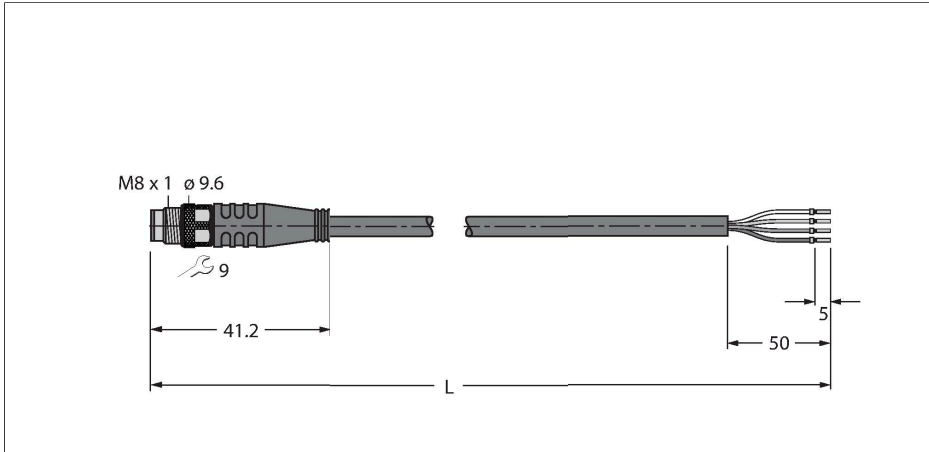

Technical data

Type	PSG4M-5/TRL
ID	6543147
Connector A	Male, M8 × 1, Straight
Number of Pins	4
Contacts	Brass, CuZn, Gold-plated
Contact carriers	Plastic, TPU, Black
Connector body	Plastic, TPU, Black
Coupling nut/screw	Brass, CuZn, Nickel-plated
Tightening torque (range)	0.5 ... 0.6 Nm (observe max. torque of mating connector!)
Mechanical lifespan	> 100 Mating cycles
Pollution degree	3
Protection class	IP67, IP69K, Only in screwed condition
Cable	
Cable diameter	Ø 4.5 mm ±0.20
Cable length	5 m
Cable jacket	PUR, Black
Core insulation	PP
Core cross-section	4 x 0.34 mm ²
Arrangement of strands	42 x 0.1 mm
Core colors	BN, WH, BU, BK
Electrical properties at +20 °C	
Rated voltage	50 V _{AC} /60 V _{DC}
Test voltage	2000 V
Current	4 A

Features



- Male M8, straight, 4-pin
- Jacket material: PUR
- Jacket color: black
- Torsion resistant ($\pm 360^\circ/\text{m}$)
- Resistant to chemicals, UV radiation and oils
- Free from halogen, silicone, PVC and LABS
- Flame retardant
- Resistant to hydrolysis and microbes
- Protection class: IP67, IP69K
- Cable length: 5.0 m

Cable Cross-Section

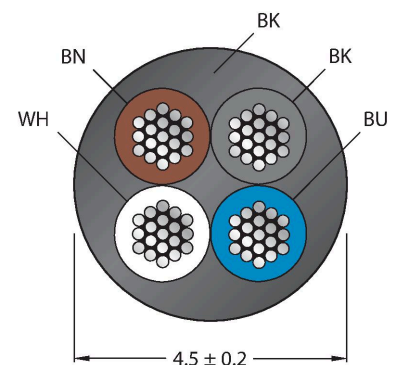

Contact assignment

Technical data

Mechanical and chemical properties	
Bending radius (stationary installation)	$\geq 5 \times \varnothing$
Bending radius (flexible use)	$\geq 10 \times \varnothing$
Torsional stress	$\pm 360 \text{ }^\circ/\text{m}$
Torsion cycles	Max. 5 million
Torsion speed	20 Cycles/min
Ambient temperature (fixed)	-50...+80 °C
Ambient temperature (mobile)	-25...+80 °C
Halogen-free	Acc. to IEC 60754-1-2
LABS free	Acc. to PV3.10.7
Oil-resistant	Acc. to EN 60811-2-1
Flame-retardant	Acc. to IEC 60332-2-2, FT2
Approvals	cULus CE UKCA



Functional principle

Drawing shows design status including hexagon coupling nut (Production start CW11/2016).

Circuit Diagram

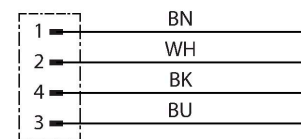

Accessories

TORQUE-WRENCH-SET-AS	6936170	Torque wrench set; handles with adjustable torque 0.4-1.0 Nm, torque wrench for M8 (SW9), fork wrench for M12 (SW 14)	BLANK-LABEL-FOR-CORDSETS-TEL-TXL	6936206	Label for TEL and TXL cables, length: 18 mm, height: 4 mm, material: polycarbonate (PC), color: white, halogen-free and flame-retardant
HA5141-0	6905405	Field-wireable female connector, M8 × 1, straight, 4-pin, insulation piercing connection, cable feedthrough 2.5 to 5.1 mm, core cross-section/terminal capacity 0.14 to 0.34 mm ² , plastic housing, metal nut	B5143-0	6901031	Konfektionierbare Kupplung, M8 × 1, gerade, 4-polig, Schraubklemmanschluss, Leitungsdurchlass 3.5 bis 5.0 mm, Adernquerschnitt/ Klemmvermögen 0.14 bis 0.50 mm ² , Kunststoffgehäuse, Metallüberwurfmutter
H5141-0	6902720	Field-wireable female connector, M8 × 1, straight, 4-pin, pressfit technology, cable feedthrough 4.0 to 5.0 mm, core cross-section/terminal capacity 0.14 to 0.34 mm ² , plastic housing, metal nut	H5241-0	6902820	Field-wireable female connector, M8 × 1, angled, 4-pin, pressfit technology, cable feedthrough 4.0 to 5.0 mm, core cross-section/terminal capacity 0.14 to 0.34 mm ² , plastic housing, metal nut

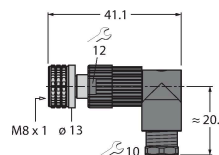
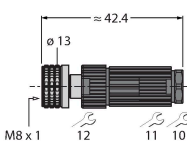
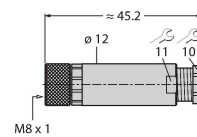
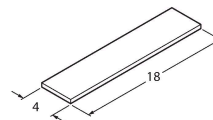
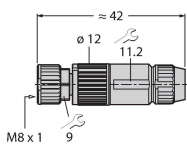

FW-PRKPM0420-SA-S-0406

100002293

Field-wireable female connector, M8 × 1, straight, 4-pin, screw terminal connection, cable feedthrough 4.0 to 5.5 mm, core cross-section/terminal capacity 0.14 to 0.5 mm², plastic housing, metal coupling nut

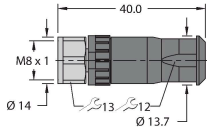

Accessories

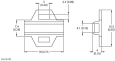
Dimension drawing	Type	ID	
	LABEL-HOLDER-FLEX-PVC	100048170	PVC label holder for identification of extension cables (TEL/TXL product series); for cable diameters: min. 5 mm; dimensions 4 × 18 mm; delivery unit: 50 pcs. per package