

TB-8M12-4-10/TXL

Passive Actuator/Sensor Box, M12 x 1 – With Homerun Cable, 8-port

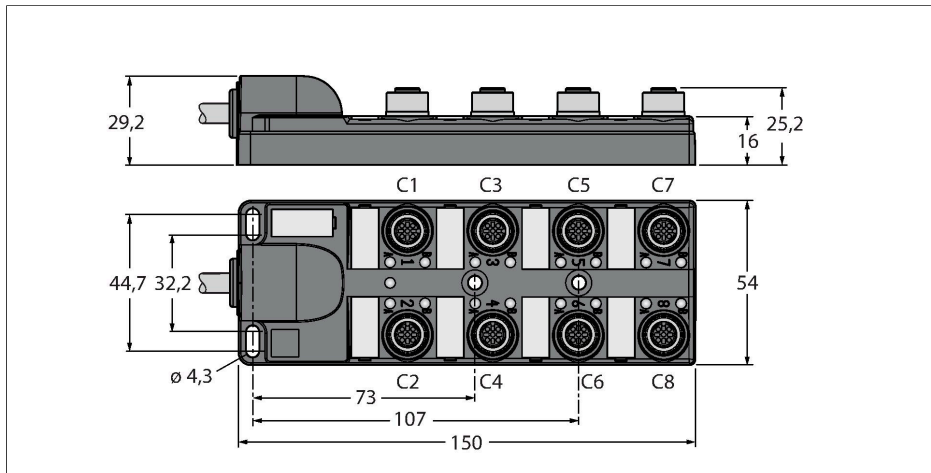

Technical data

Type	TB-8M12-4-10/TXL
ID no.	6611946
Distributed I/O	8, with integral homerun cable
Housing	Plastic, PA, Black
I/O port	M12 x 1
Number of Pins	3+PE
Contacts	Brass, CuZn, Gold-plated
Contact carriers	Plastic, PA, Black
Seal	Plastic, FPM/FKM
Mechanical lifespan	> 100 Mating cycles
Group terminal	Cable
Cable diameter	Ø 10 mm
Cable length	10 m
Cable jacket	PUR, Black
Core insulation	PVC
Core cross-section	8 x 0.82 mm ²
Cable conductor cross-section	3x 0.82 mm ²
Core colors	WH, GN, YE, GY, PK, RD, BK, VT
Core colors	BN, BU, GNYE
Electrical properties at +20 °C	
Rated voltage	30 V
Current	2 A per signal contact, total current 6 A
Insulation resistance	≥ 10 ⁸ Ω
forward resistance	≤ 5 mΩ

Features



- Housing material: Nylon
- Housing color: black
- Protection class IP67
- RoHS-compliant
- CE compliant
- I/O port (number of pins): 3-pin + PE

Contact assignment

I/O Connector



Circuit Diagram

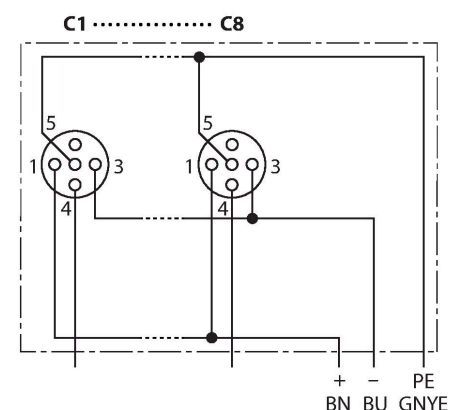

Technical data

Mechanical and chemical properties

Bending radius (stationary installation)	≥ 5 x Ø
Bending radius (flexible use)	≥ 15 x Ø
Ambient temperature range (stationary)	-40 °C...+85 °C

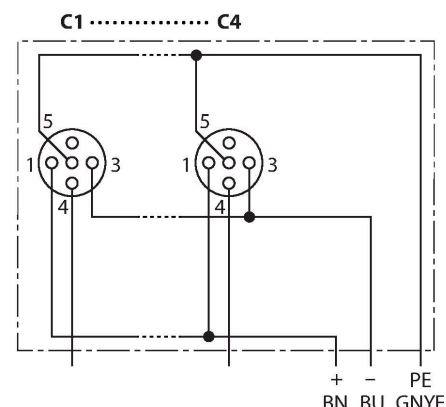

Wiring

Port/Pin	C1/4	C2/4	C3/4	C4/4	C5/4	C6/4	C7/4	C8/4
M23 flange	1	2	3	4	5	6	7	8
Cable	WH	GN	YE	GY	PK	RD	BK	VT

Power C1-C8	24V	0 V	PE
M23 flange	11	9 + 10	12
Cable	BN	BU	GNYE

Scope of delivery

Device	Quantity	Description
Junction boxes	1	Passive actuator/sensor junction box
VS-M12-BK	2	Closure caps for M12 female connectors
KS9/20	9	Labels

Accessories

Ident-No.	Designation	Description
6900197	CK12-0	Field-wireable female M23, 12-pin, straight
6931889	CS12-0	Field-wireable male M23, 12-pin, straight
6625616	RKC5T-2-RSC5T/TXL	Actuator/sensor cable, female M12 - male M12, straight, 5-pin, 2 m *
6936055	VS-M12-BK	Closure caps for M12 female connectors
8015002	KS9/20	Labels

* Other lengths available on request