

# PKW3M-0.3-PSG3M/TEL

## Actuator and Sensor Cable, PVC – Extension Cable

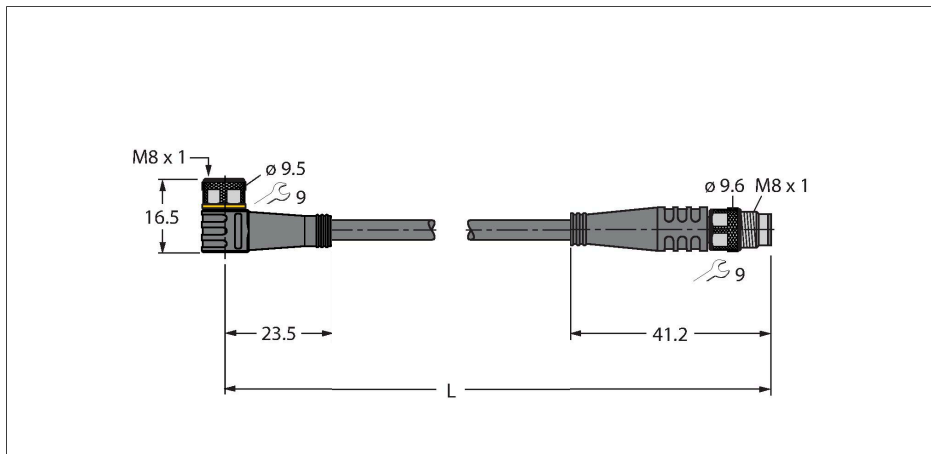

### Technical data

Type	PKW3M-0.3-PSG3M/TEL
ID	6626512
Connector A	Female, M8 × 1, Angled
Number of Pins	3
Contacts	Brass, CuZn, Gold-plated
Contact carriers	Plastic, TPU, Black
Connector body	Plastic, TPU, Black
Coupling nut/screw	Brass, CuZn, Nickel-plated
Seal	Plastic, FPM/FKM
Tightening torque (range)	0.5 ... 0.6 Nm (observe max. torque of mating connector!)
Mechanical lifespan	> 100 Mating cycles
Pollution degree	3
Protection class	IP67, IP69K, Only in screwed condition
Connector B	Male, M8 × 1, Straight
Number of pins	3
Contacts	Brass, CuZn, Gold-plated
Contact carriers	Plastic, TPU, Black
Connector body	Plastic, TPU, Black
Coupling nut/retaining screw	Brass, CuZn, Nickel-plated
Tightening torque	0.5 ... 0.6 Nm (observe max. torque of mating connector!)
Mechanical life	> 100 Mating cycles
Pollution degree	3
Protection class	IP67, IP69K, Only when screwed together
Cable	
Cable diameter	Ø 4.3 mm ±0.20

### Features



- Female M8, angled, 3-pin
- Male M8, straight, 3-pin
- Jacket material: PVC
- Jacket color: black
- Resistant to chemicals and oils
- Flame retardant
- Resistant to acids and alkaline solutions
- Resistant to microbes and hydrolysis
- LABS free
- Protection class: IP67, IP69K
- Cable length: 0.3 m

### Cable Cross-Section

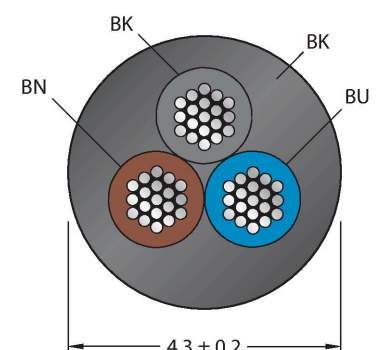

### Contact assignment

## Technical data

Cable length	0.3 m
Cable jacket	PVC, Black
Core insulation	PVC
Core cross-section	3 x 0.34 mm <sup>2</sup>
Arrangement of strands	42 x 0.1 mm
Core colors	BN, BU, BK
<b>Electrical properties at +20 °C</b>	
Rated voltage	50 V <sub>AC</sub> /60 V <sub>DC</sub>
Test voltage	2000 V
Current	4 A
Insulation resistance	> 30.5 MΩ/km
forward resistance	max. 57 Ω/km
<b>Mechanical and chemical properties</b>	
Bending radius (stationary installation)	≥ 5 x Ø
Bending radius (flexible use)	≥ 10 x Ø
Ambient temperature range (stationary)	-40...+105 °C
Ambient temperature range (In motion)	-5...+80 °C
Approvals	cULus



## Circuit Diagram



## Accessories

TORQUE-WRENCH-SET-AS	6936170
Torque wrench set; handles with adjustable torque 0.4-1.0 Nm, torque wrench for M8 (SW9), fork wrench for M12 (SW 14)	

BLANK-LABEL-FOR-CORDSETS-TEL-TXL	6936206
Label for TEL and TXL cables, length: 18 mm, height: 4 mm, material: polycarbonate (PC), color: white, halogen-free and flame-retardant	

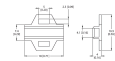

## Accessories

Dimension drawing	Type	ID	
	LABEL-HOLDER-FLEX-PVC	100048170	PVC label holder for identification of extension cables (TEL/TXL product series); for cable diameters: min. 5 mm; dimensions 4 x 18 mm; delivery unit: 50 pcs. per package