

RKS4.5T-15/TEL

Actuator and Sensor Cable, PVC – Connection Cable

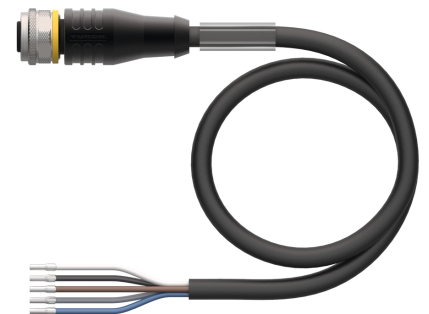
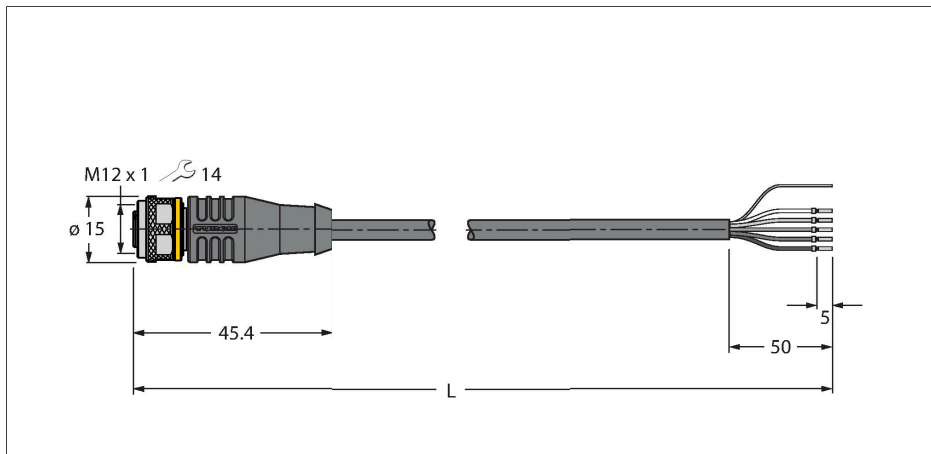

Technical data

Type	RKS4.5T-15/TEL
ID	6627832
Connector A	Female, M12 × 1, Straight, A-coded
Number of Pins	5
Contacts	Brass, CuZn, Gold-plated
Contact carriers	Plastic, TPU, Black
Connector body	Plastic, TPU, Black
Coupling nut/screw	Brass, CuZn, Nickel-plated
Seal	Plastic, FPM/FKM
Mechanical lifespan	> 100 Mating cycles
Pollution degree	3
Protection class	IP67, IP69K, Only in screwed condition
Cable	
Cable diameter	Ø 6.1 mm ±0.20
Cable length	15 m
Cable jacket	PVC, Black
Shielding	Aluminum foil, tinned copper wire
Core insulation	PVC
Core cross-section	5 x 0.34 mm ²
Arrangement of strands	42 x 0.1 mm
Core colors	BN, WH, BU, BK, GY
Electrical properties at +20 °C	
Rated voltage	60 V
Test voltage	2000 V
Current	4 A
Insulation resistance	> 30.5 MΩ/km
forward resistance	max. 57 Ω/km

Features



- Female M12, straight, 5-pin
- Shield on coupling nut/screw
- Jacket material: PVC, shielded
- Jacket color: black
- Resistant to chemicals and oils
- Flame retardant
- Resistant to acids and alkaline solutions
- Resistant to microbes and hydrolysis
- LABS free
- Protection class: IP67, IP69K
- Cable length: 15 m

Cable Cross-Section

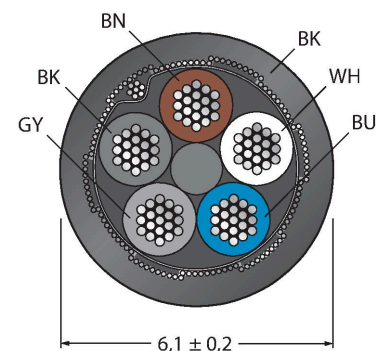

Contact assignment

Technical data

Mechanical and chemical properties	
Bending radius (stationary installation)	≥ 5 x Ø
Bending radius (flexible use)	≥ 10 x Ø
Ambient temperature range (stationary)	-40...+105 °C
Ambient temperature range (In motion)	0...+80 °C
Approvals	cULus



Circuit Diagram



Accessories

CMBS8151-0 6930161

Field-wireable male connector, M12 × 1, straight, 5-pin, screw terminal connection, cable feedthrough 6.0 to 8.0 mm, core cross-section/terminal capacity 0.14 to 0.75 mm², metal housing, metal nut, shieldable

CMBS8251-0 6930216

Field-wireable male connector, M12 × 1, angled, 5-pin, screw terminal connection, cable feedthrough 6.0 to 8.0 mm, core cross-section/terminal capacity 0.14 to 0.75 mm², metal housing, metal nut, shieldable

TORQUE-WRENCH-SET-AS 6936170

Torque wrench set; handles with adjustable torque 0.4-1.0 Nm, torque wrench for M8 (SW9), fork wrench for M12 (SW 14)

BLANK-LABEL-FOR-CORDSETS-TEL-TXL 6936206

Label for TEL and TXL cables, length: 18 mm, height: 4 mm, material: polycarbonate (PC), color: white, halogen-free and flame-retardant

Accessories

Dimension drawing	Type	ID	
	LABEL-HOLDER-FLEX-PVC	100048170	PVC label holder for identification of extension cables (TEL/TXL product series); for cable diameters: min. 5 mm; dimensions 4 × 18 mm; delivery unit: 50 pcs. per package