

VBRS4.4-2PKG3M-2/2/TEL

2-Way Splitter – Y-Splitter with Cable, Male M12 × 1 - 2x Female M8 × 1

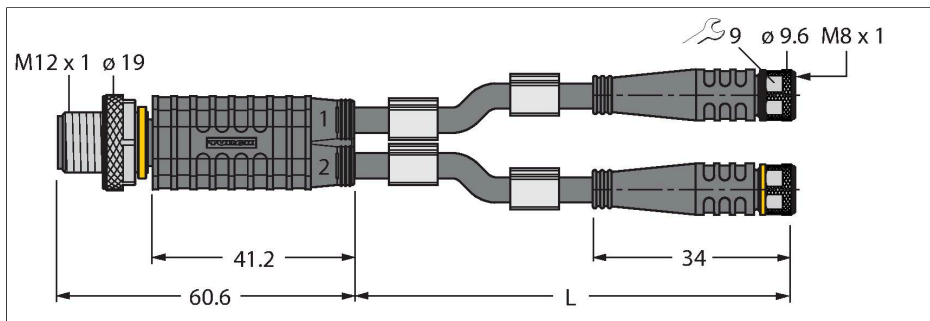

Technical data

Type	VBRS4.4-2PKG3M-2/2/TEL
ID	6629196
Distributed I/O	Y-splitter, 2 -port
Connector A	Male, M12 × 1, Straight
Number of Pins	4
Contacts	Metal, CuZn, Gold-plated
Contact carriers	Plastic, TPU, Black
Connector body	Plastic, TPU, Black
Coupling nut/screw	Brass, CuZn, Nickel-plated
Tightening torque (range)	0.8 ... 1 Nm (observe max. torque of mating connector!)
Mechanical lifespan	> 100 Mating cycles
Pollution degree	3
Protection class	IP67, Only in screwed condition
Connector B	2 x Female, M8 × 1, Straight
Number of pins	3
Contacts	Metal, CuZn, Gold-plated
Contact carriers	Plastic, TPU, Black
Connector body	Plastic, TPU, Black
Coupling nut/retaining screw	Brass, CuZn, Nickel-plated
Seal	Plastic, FPM/FKM
Tightening torque	0.5 ... 0.6 Nm (observe max. torque of mating connector!)
Mechanical life	> 100 Mating cycles
Pollution degree	3
Protection class	IP67, Only when screwed together
Cable diameter	Ø 4.7 mm ±0.20
Cable length	2 m, 2 m
Cable jacket	PVC, Black

Features



- Jacket material: PVC
- Jacket color: black
- Resistant to chemicals and oils
- Flame-retardant
- Resistant to acids and alkaline solutions
- Resistant to microbes and hydrolysis
- LABS free
- RoHS-compliant
- Protection class IP67
- 4/3-pin
- Cable length: 2.0/2.0 meter

Cable Cross-Section

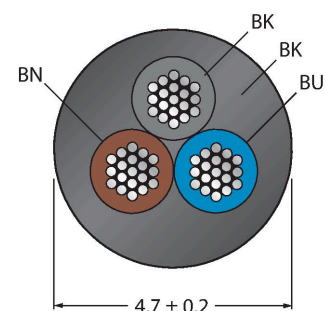

Contact assignment

Technical data

Core insulation	PVC
Core cross-section	3 x 0.34 mm ²
Arrangement of strands	42 x 0.1 mm
Core colors	BN, BU, BK
Electrical properties at +20 °C	
Rated voltage	60 V
Test voltage	2000 V
Current	4 A
Insulation resistance	> 30.5 MΩ/km
forward resistance	max. 57 Ω/km
Mechanical and chemical properties	
Bending radius (stationary installation)	≥ 5 x Ø
Bending radius (flexible use)	≥ 10 x Ø
Ambient temperature range (stationary)	-40...+105 °C
Ambient temperature range (In motion)	0...+80 °C



Accessories

TORQUE-WRENCH-SET-AS	6936170
Torque wrench set; handles with adjustable torque 0.4-1.0 Nm, torque wrench for M8 (SW9), fork wrench for M12 (SW 14)	

BLANK-LABEL-FOR-CORDSETS-TEL-TXL	6936206
Label for TEL and TXL cables, length: 18 mm, height: 4 mm, material: polycarbonate (PC), color: white, halogen-free and flame-retardant	

