

PKG3M-10-PSG3M/TEY

Actuator and Sensor Cable, PVC – Extension Cable

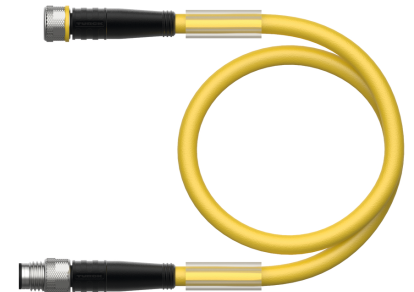
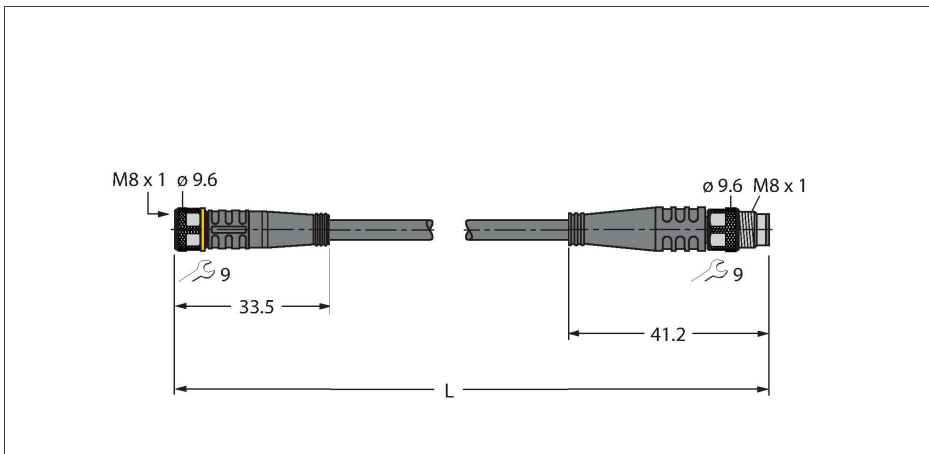

Technical data

Type	PKG3M-10-PSG3M/TEY
ID	6629314
Connector A	Female, M8 × 1, Straight
Number of Pins	3
Contacts	Brass, CuZn, Gold-plated
Contact carriers	Plastic, TPU, Black
Connector body	Plastic, TPU, Black
Coupling nut/screw	Brass, CuZn, Nickel-plated
Seal	Plastic, FPM/FKM
Tightening torque (range)	0.5 ... 0.6 Nm (observe max. torque of mating connector!)
Mechanical lifespan	> 100 Mating cycles
Pollution degree	3
Protection class	IP67, IP69K, Only in screwed condition
Connector B	Male, M8 × 1, Straight
Number of pins	3
Contacts	Brass, CuZn, Gold-plated
Contact carriers	Plastic, TPU, Black
Connector body	Plastic, TPU, Black
Coupling nut/retaining screw	Brass, CuZn, Nickel-plated
Tightening torque	0.5 ... 0.6 Nm (observe max. torque of mating connector!)
Mechanical life	> 100 Mating cycles
Pollution degree	3
Protection class	IP67, IP69K, Only when screwed together

Features



- Female M8, straight, 3-pin
- Male M8, straight, 3-pin
- Jacket material: PVC
- Jacket color: yellow
- Resistant to chemicals and oils
- Flame retardant
- Resistant to acids and alkaline solutions
- Resistant to microbes and hydrolysis
- LABS free
- Protection class: IP67, IP69K
- Cable length: 10 m

Cable Cross-Section

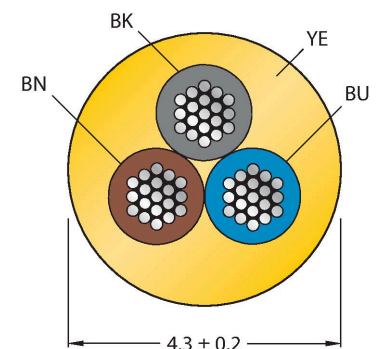

Contact assignment

Technical data

Cable	
Cable diameter	Ø 4.3 mm ±0.20
Cable length	10 m
Cable jacket	PVC, Yellow
Core insulation	PVC
Core cross-section	3 x 0.34 mm ²
Arrangement of strands	42 x 0.1 mm
Core colors	BN, BU, BK
Electrical properties at +20 °C	
Rated voltage	50 V _{AC} /60 V _{DC}
Test voltage	2000 V
Current	4 A
Insulation resistance	> 30.5 MΩ/km
forward resistance	max. 57 Ω/km
Mechanical and chemical properties	
Bending radius (stationary installation)	≥ 5 x Ø
Bending radius (flexible use)	≥ 10 x Ø
Ambient temperature range (stationary)	-40...+105 °C
Ambient temperature range (In motion)	0...+80 °C
Approvals	cULus

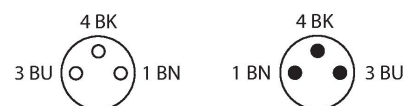

Circuit Diagram

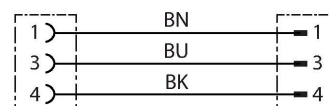

Accessories

TORQUE-WRENCH-SET-AS	6936170	BLANK-LABEL-FOR-CORDSETS-TEL-TXL	6936206
Torque wrench set; handles with adjustable torque 0.4-1.0 Nm, torque wrench for M8 (SW9), fork wrench for M12 (SW 14)		Label for TEL and TXL cables, length: 18 mm, height: 4 mm, material: polycarbonate (PC), color: white, halogen-free and flame-retardant	

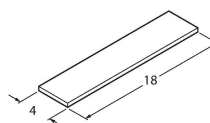

Accessories

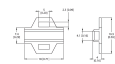
Dimension drawing	Type	ID	
	LABEL-HOLDER-FLEX-PVC	100048170	PVC label holder for identification of extension cables (TEL/TXL product series); for cable diameters: min. 5 mm; dimensions 4 x 18 mm; delivery unit: 50 pcs. per package