

RKC4.4T-P7X2-20/TXO

Actuator and Sensor Cable, PUR – Connection Cable

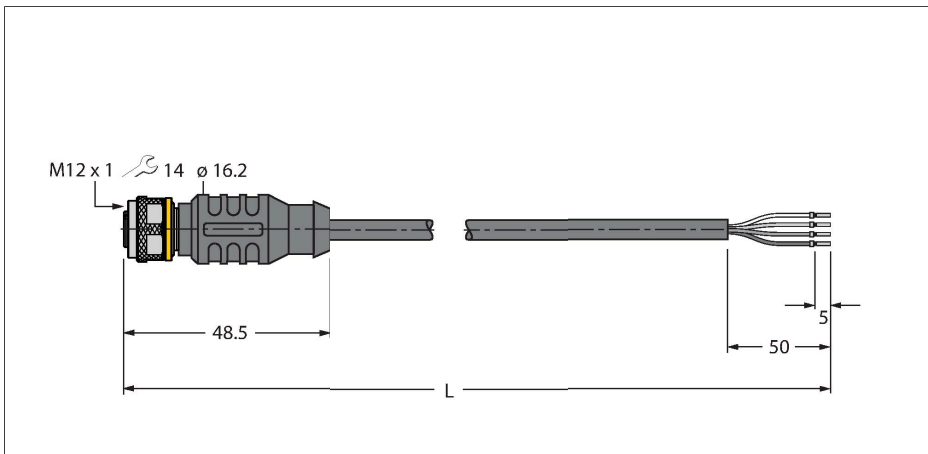

Features



- M12 female connector, straight, 4-pin
- With 2-color LED (PNP, yellow, green), all-round visibility
- Jacket material: PUR
- Jacket color: orange
- Suitable for drag chain use
- Resistant to chemicals, UV radiation and oils
- Flame retardant (FT2 acc. to UL 1581, IEC 60332-2-2)
- Resistant to welding sparks
- Free from halogen, silicone, PVC and LABS
- Particularly resistant to abrasion
- Protection class: IP67, IP69K
- Cable length: 20 m

Technical data

Type	RKC4.4T-P7X2-20/TXO
ID	6636100
Connector A	Female, M12 × 1, Straight, A-coded
Number of Pins	4
Contacts	Brass, CuZn, Gold-plated
Contact carriers	Plastic, TPU, Black
Connector body	Plastic, TPU, Translucent
Coupling nut/screw	Brass, CuZn, Nickel-plated
Seal	Plastic, FPM/FKM
LED display	dual LED
Display operating voltage	LED, Green
Display switch state	LED, Yellow
Mechanical lifespan	> 100 Mating cycles
Pollution degree	3
Protection class	IP67, IP69K, Only in screwed condition
Cable	
Cable diameter	Ø 4.5 mm ±0.20
Cable length	20 m
Cable jacket	PUR, Orange
Core insulation	PP
Core cross-section	4 x 0.34 mm ²
Arrangement of strands	42 x 0.1 mm
Core colors	BN, WH, BU, BK
Electrical properties at +20 °C	
Rated voltage	30 V _{dc}
Test voltage	2000 V
Current	4 A

Cable Cross-Section

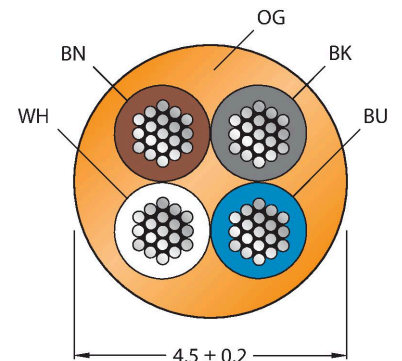

Contact assignment

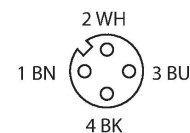

Circuit Diagram

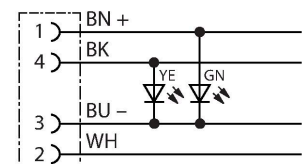

Technical data

Insulation resistance	> 30.5 MΩ/km
forward resistance	max. 57 Ω/km
Mechanical and chemical properties	
Bending radius (stationary installation)	≥ 5 x Ø
Bending radius (flexible use)	≥ 10 x Ø
Bending cycles	≥ 5 million
Admissible acceleration	max. 5 m/s ²
Admissible travel path, horizontal	5 m (at 5 m/s ²)
Admissible travel path, vertical	2 m (at 5 m/s ²)
Admissible traversing speed	3.3 m/s
Torsional stress	± 180 °/m
Ambient temperature range (stationary)	-50...+80 °C
Ambient temperature range (In motion)	-25...+80 °C
Ambient temperature during drag chain operation	-25...+60 °C

Accessories

TORQUE-WRENCH-SET-AS 6936170	Torque wrench set; handles with adjustable torque 0.4-1.0 Nm, torque wrench for M8 (SW9), fork wrench for M12 (SW 14)	BLANK-LABEL-FOR-CORDSETS-TEL-TXL 6936206	Label for TEL and TXL cables, length: 18 mm, height: 4 mm, material: polycarbonate (PC), color: white, halogen-free and flame-retardant
HAS8141-0 6905406	Field-wireable male connector, M12 × 1, straight, 4-pin, insulation piercing connection, cable feedthrough 4.0 to 5.1 mm, core cross-section/terminal capacity 0.14 to 0.34 mm ² , plastic housing, metal nut	HAS8241-0 6905400	Field-wireable male connector, M12 × 1, angled, 4-pin, insulation piercing connection, cable feedthrough 4.0 to 5.1 mm, core cross-section/terminal capacity 0.14 to 0.34 mm ² , plastic housing, metal nut
BS8141-0 69010	Field-wireable male connector, M12 × 1, straight, 4-pin, screw terminal connection, cable feedthrough 4.0 to 6.0 mm, core cross-section/terminal capacity 0.14 to 0.75 mm ² , plastic housing, metal retaining screw	BS8241-0 69011	Field-wireable connector, M12 × 1, angled, 4-pin, screw terminal connection, cable feedthrough 4.0 to 6.0 mm, core cross-section/terminal capacity 0.14 to 0.75 mm ² , plastic housing, metal retaining screw

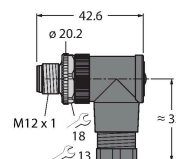
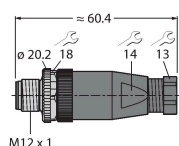
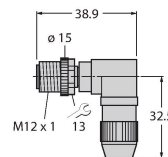
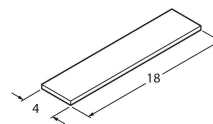
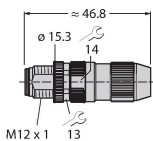

FW-ERSPM0426-SA-P-0408

100002048

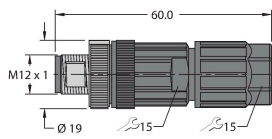

Field-wireable male connector, M12 × 1, straight, 4-pin, push-in connection, cable feedthrough 4.0 to 8.0 mm, core cross-section/terminal capacity 0.14 to 0.75 mm², plastic housing, metal retaining screw

FW-ERSPM0416-SA-S-0408

100002288

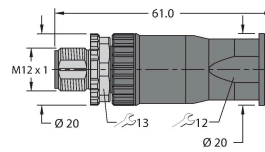

Field-wireable male connector, M12 × 1, straight, 4-pin, screw terminal connection, cable feedthrough 4.0 to 8.0 mm, core cross-section/terminal capacity 0.25 to 1.5 mm², plastic housing, metal retaining screw

FW-EWSPM0416-SA-S-0408

100002290

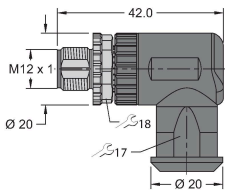

Field-wireable male connector, M12 × 1, angled, 4-pin, screw terminal connection, cable feedthrough 4.0 to 8.0 mm, core cross-section/terminal capacity 0.25 to 1.5 mm², plastic housing, metal retaining screw

Accessories

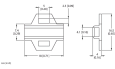
Dimension drawing	Type	ID	
	LABEL-HOLDER-FLEX-PVC	100048170	PVC label holder for identification of extension cables (TEL/TXL product series); for cable diameters: min. 5 mm; dimensions 4 × 18 mm; delivery unit: 50 pcs. per package