

# RKCV4.4T-50/TXL

## Actuator and Sensor Cable, PUR – Connection Cable

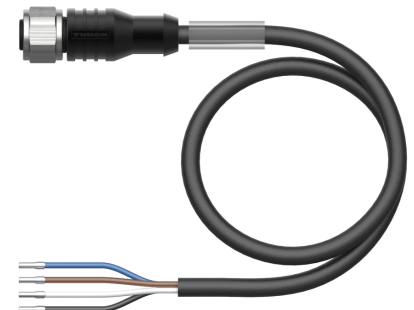
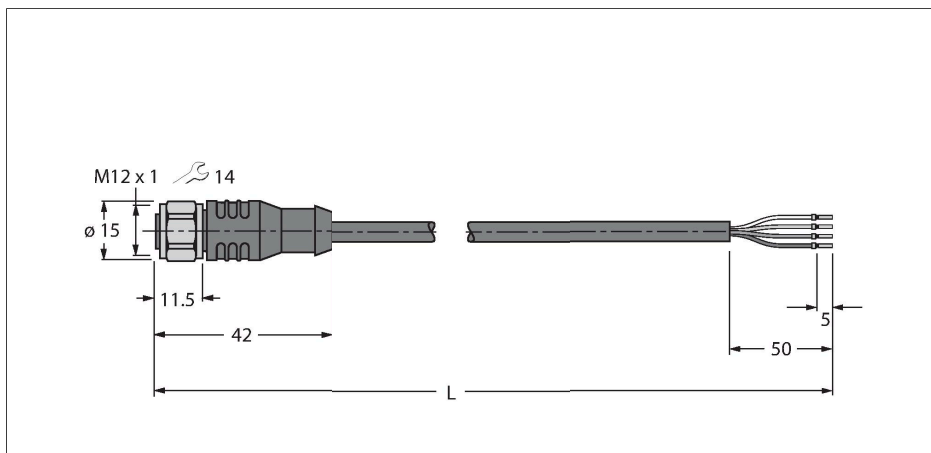

### Technical data

Type	RKCV4.4T-50/TXL
ID	6636417
Connector A	Female, M12 × 1, Straight, A-coded
Number of Pins	4
Contacts	Brass, CuZn, Gold-plated
Contact carriers	Plastic, TPU, Black
Connector body	Plastic, TPU, Black
Coupling nut/screw	Stainless Steel, V4A
Seal	Plastic, FPM/FKM
Mechanical lifespan	> 100 Mating cycles
Pollution degree	3
Protection class	IP67, IP69K, Only in screwed condition
<b>Cable</b>	
Cable diameter	Ø 4.5 mm ±0.20
Cable length	50 m
Cable jacket	PUR, Black
Core insulation	PP
Core cross-section	4 x 0.34 mm <sup>2</sup>
Arrangement of strands	42 x 0.1 mm
Core colors	BN, WH, BU, BK
<b>Electrical properties at +20 °C</b>	
Rated voltage	250 V
Test voltage	2000 V
Current	4 A
Insulation resistance	> 30.5 MΩ/km
forward resistance	max. 57 Ω/km

### Features



- Female M12, straight, 4-pin
- Stainless steel coupling nut/screw
- Jacket material: PUR
- Jacket color: black
- Suitable for drag chain use
- Resistant to chemicals, UV radiation and oils
- Flame retardant (FT2 acc. to UL 1581, IEC 60332-2-2)
- Resistant to welding sparks
- Free from halogen, silicone, PVC and LABS
- Particularly resistant to abrasion
- Protection class: IP67, IP69K
- Cable length: 50 m

### Cable Cross-Section

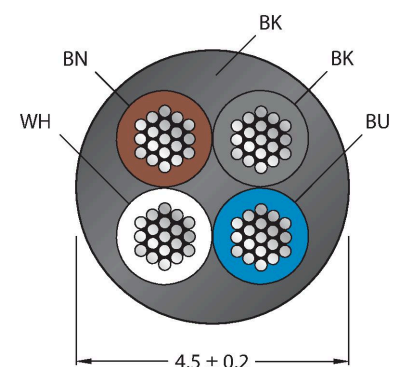

### Contact assignment

## Technical data

Mechanical and chemical properties	
Bending radius (stationary installation)	$\geq 5 \times \varnothing$
Bending radius (flexible use)	$\geq 10 \times \varnothing$
Bending cycles	$\geq 5$ million
Admissible acceleration	max. 5 m/s <sup>2</sup>
Admissible travel path, horizontal	5 m (at 5 m/s <sup>2</sup> )
Admissible travel path, vertical	2 m (at 5 m/s <sup>2</sup> )
Admissible traversing speed	3.3 m/s
Torsional stress	$\pm 180$ °/m
Ambient temperature range (stationary)	-50...+80 °C
Ambient temperature range (In motion)	-25...+80 °C
Ambient temperature during drag chain operation	-25...+60 °C
Approvals	cULus



## Circuit Diagram



## Accessories

TORQUE-WRENCH-SET-AS	6936170	Torque wrench set; handles with adjustable torque 0.4-1.0 Nm, torque wrench for M8 (SW9), fork wrench for M12 (SW 14)	BLANK-LABEL-FOR-CORDSETS-TEL-TXL	6936206	Label for TEL and TXL cables, length: 18 mm, height: 4 mm, material: polycarbonate (PC), color: white, halogen-free and flame-retardant
HAS8141-0	6905406	Field-wireable male connector, M12 × 1, straight, 4-pin, insulation piercing connection, cable feedthrough 4.0 to 5.1 mm, core cross-section/terminal capacity 0.14 to 0.34 mm <sup>2</sup> , plastic housing, metal nut	HAS8241-0	6905400	Field-wireable male connector, M12 × 1, angled, 4-pin, insulation piercing connection, cable feedthrough 4.0 to 5.1 mm, core cross-section/terminal capacity 0.14 to 0.34 mm <sup>2</sup> , plastic housing, metal nut
BS8141-0	69010	Field-wireable male connector, M12 × 1, straight, 4-pin, screw terminal connection, cable feedthrough 4.0 to 6.0 mm, core cross-section/terminal capacity 0.14 to 0.75 mm <sup>2</sup> , plastic housing, metal retaining screw	BS8241-0	69011	Field-wireable connector, M12 × 1, angled, 4-pin, screw terminal connection, cable feedthrough 4.0 to 6.0 mm, core cross-section/terminal capacity 0.14 to 0.75 mm <sup>2</sup> , plastic housing, metal retaining screw

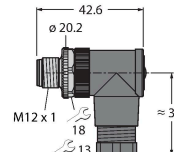
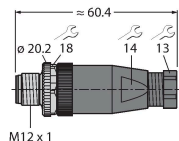
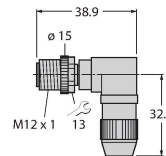
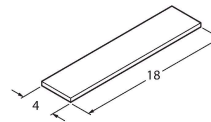
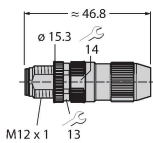

FW-ERSPM0426-SA-P-0408

100002048

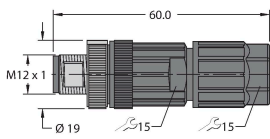

Field-wireable male connector, M12 × 1, straight, 4-pin, push-in connection, cable feedthrough 4.0 to 8.0 mm, core cross-section/terminal capacity 0.14 to 0.75 mm<sup>2</sup>, plastic housing, metal retaining screw

FW-ERSPM0416-SA-S-0408

100002288



Field-wireable male connector, M12 × 1, straight, 4-pin, screw terminal connection, cable feedthrough 4.0 to 8.0 mm, core cross-section/terminal capacity 0.25 to 1.5 mm<sup>2</sup>, plastic housing, metal retaining screw

FW-EWSPM0416-SA-S-0408

100002290



Field-wireable male connector, M12 × 1, angled, 4-pin, screw terminal connection, cable feedthrough 4.0 to 8.0 mm, core cross-section/terminal capacity 0.25 to 1.5 mm<sup>2</sup>, plastic housing, metal retaining screw

## Accessories

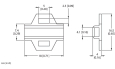
Dimension drawing	Type	ID	
	LABEL-HOLDER-FLEX-PVC	100048170	PVC label holder for identification of extension cables (TEL/TXL product series); for cable diameters: min. 5 mm; dimensions 4 × 18 mm; delivery unit: 50 pcs. per package