

BL67 electronic module

8 Digital Inputs, PNP

BL67-8DI-P

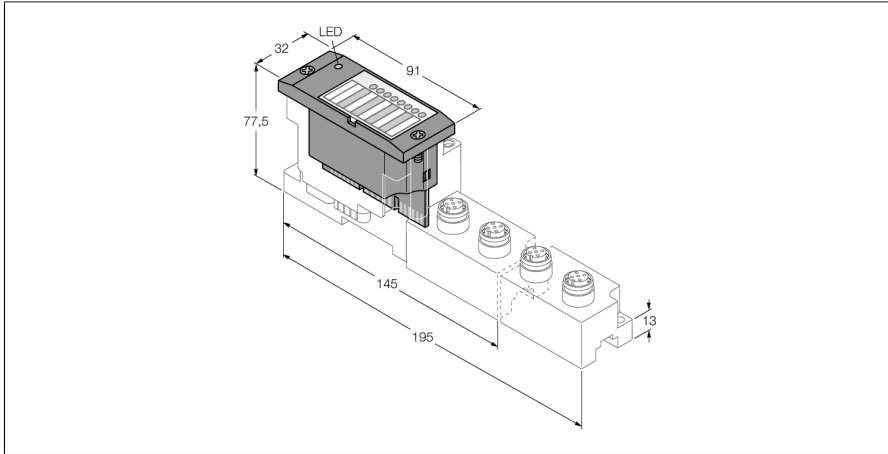

- Independent of the fieldbus and connection technology used
- Protection class IP67
- LEDs indicate status and diagnostic
- Electronics galvanically separated from the field level via optocouplers
- 8 digital inputs, 24 VDC
- PNP switching
- From version VN 01-03 and higher, the module supports accelerated start-up for applications with Fast Start-Up (FSU) and QuickConnect (QC).

Functional principle

BL67 electronic modules are plugged on the purely passive base modules which in turn are connected to the field devices. The separation of connection level and electronics simplifies maintenance considerably. Flexibility is enhanced because the user can choose between base modules with different connection technologies.

The electronic modules are completely independent of the higher level fieldbus through the use of gateways.

Type	BL67-8DI-P
ID	6827170
Number of channels	8
Supply voltage	24 VDC
Nominal voltage V_i	24 VDC
Nominal current from field supply	≤ 40 mA
Nominal current from module bus	≤ 30 mA
Max. sensor supply I_{sens}	4 A electronically limited current supply via gateway or power feed
Power dissipation, typical	≤ 0.25 W



Input type	PNP
Type of input diagnostics	group diagnostics
Low-level signal voltage	< 4.5 V
High level signal voltage	7...30 V
Low level signal current	< 1.5 mA
High level signal current	2.1...3.7 mA
Input delay	0.25 ms
Electrical isolation	electronics for the field level
Output connectivity	M8, M12, M23

Dimensions (W x L x H)	32 x 91 x 59 mm
Approvals	CE, cULus
Ambient temperature	-40...+70 °C
Temperature derating	
< 0 °C Ambient temperature	switching on threshold drop, 1mA < Ie < 2.5mA
> 55 °C Steady ambient air	Simultaneity factor 0.5
Storage temperature	-40...+85 °C
Relative humidity	5...95 % (internal), level RH-2, no condensation (when stored at 45 °C)
Vibration test	Acc. to EN 61131
- up to 5 g (at 10 to 150 Hz)	for mounting on DIN rail no drilling according to EN 60715, with end bracket
- up to 20 g (at 10 up to 150 Hz)	for mounting on base plate or machinery Therefore every second module has to be mounted with two screws each.
Shock test	Acc. to IEC 60068-2-27
Drop and topple	acc. to IEC 68-2-31 and free fall to IEC 68-2-32
Electromagnetic compatibility	Acc. to EN 61131-2
Protection class	IP67
Tightening torque fixing screw	0.9...1.2 Nm

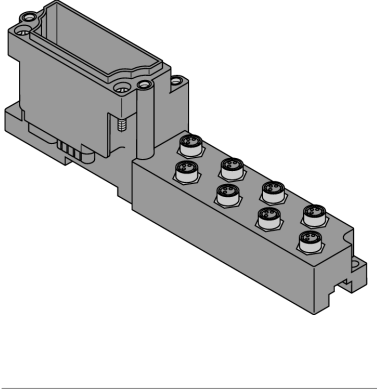
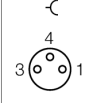
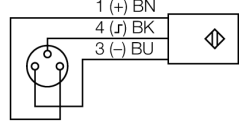
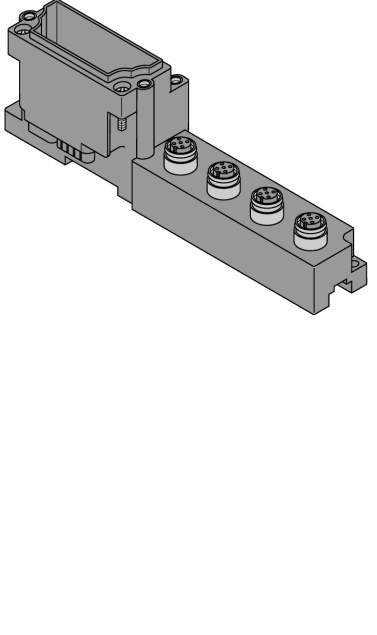
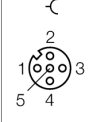
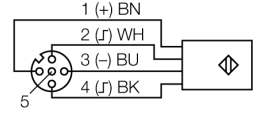
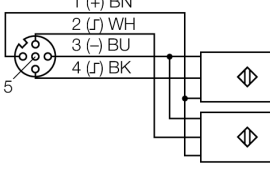
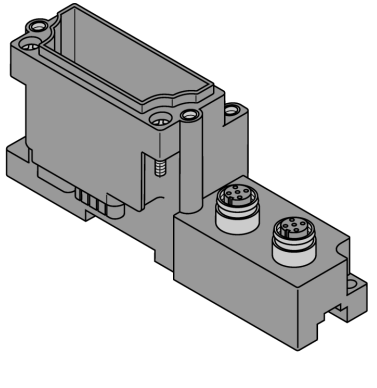
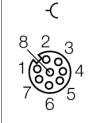
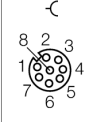
Compatible base modules

Dimension drawing	Type	Pin configuration
	<p>BL67-B-8M8 6827188 8 x M8, 3-pole, female</p> <p>Comments Matching connection cable (for example): PKG3M-2-PSW3M/TXL Ident-No. 6625668</p>	<p>Pin Assignment</p>  <p>1 = V_{SENS} 3 = GND 4 = Input A</p> <p>Wiring Diagram</p> 
	<p>BL67-B-4M12 6827187 4 x M12, 5-pole, female</p> <p>Comments Matching connection cable (for example): RKC4.4T-2-RSC4.4T/TXL Ident-No. 6625608 Y-piece for single assignment: YB2-FSM5-2FKM5.4/S1063 Ident-No. 6930551</p> <p>BL67-B-4M12-P 6827195 4 x M12, 5-pole, female, paired</p> <p>Comments Matching connection cable (for example): RKC4.4T-2-RSC4.4T/TXL Ident-No. 6625608 Y-piece for single assignment: YB2-FSM5-2FKM5.4/S1063 Ident-No. 6930551</p>	<p>Pin Assignment</p>  <p>1 = V_{SENS} 2 = Input B 3 = GND 4 = Input A 5 = PE</p> <p>Wiring Diagram</p>  <p>Wiring diagram</p> 
	<p>BL67-B-2M12-8 6827336 2 x M12, 8-pin, female</p> <p>Comments Field-wireable connector (for example): BS8181-0 Ident. no. 6901004</p>	<p>Pin assignment slot 0</p>  <p>1 = Signal 1 5 = V_{SENS} 2 = Signal 3 6 = V_{SEN1} 3 = Signal 5 7 = GND 4 = Signal 7 8 = PE</p> <p>Pin assignment slot 1</p>  <p>1 = Signal 1 5 = V_{SENS} 2 = Signal 3 6 = V_{SEN1} 3 = Signal 5 7 = GND 4 = Signal 7 8 = PE</p>

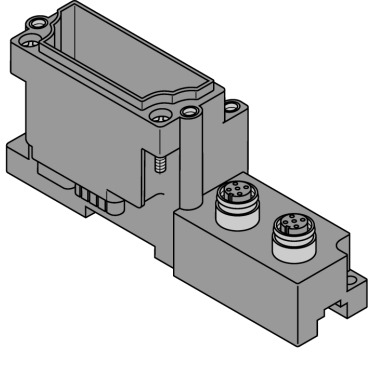
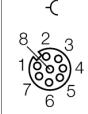
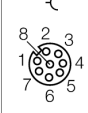
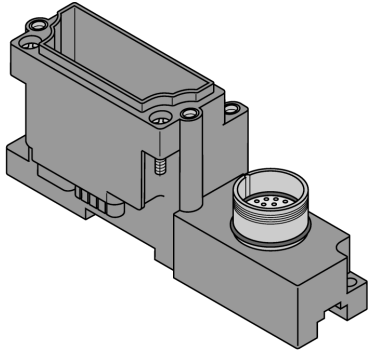
Compatible base modules

Dimension drawing	Type	Pin configuration
	<p>BL67-B-2M12-8-P 6827337 2 x M12, 8-pin, female, paired</p> <p>Comments Field-wireable connector (for example): BS8181-0 Ident. no. 6901004</p>	<p>Pin assignment slot 0</p>  <p>1 = Signal 0 5 = V_{SENS} 2 = Signal 1 6 = V_{SEN0} 3 = Signal 4 7 = GND 4 = Signal 5 8 = PE</p> <p>Pin assignment slot 1</p>  <p>1 = Signal 2 5 = V_{SENS} 2 = Signal 3 6 = V_{SEN1} 3 = Signal 6 7 = GND 4 = Signal 7 8 = PE</p>
	<p>BL67-B-1M23 6827213 1 x M23, 12-pole, female</p> <p>Comments field-wireable connector (for example): FW-M23ST12Q-G-LT-ME-XX-10 Ident-No. 6604070</p>	<p>Pin Assignment</p>  <p>1 = Signal 0 7 = Signal 6 2 = Signal 1 8 = Signal 7 3 = Signal 2 9 = V_{SENS} 4 = Signal 3 10 = V_{SENS} 5 = Signal 4 11 = V_{SENS} 6 = Signal 5 12 = GND</p>

LED display

LED	Color	Status	Meaning
D		OFF	No error message or diagnostics active.
	RED	ON	Failure of module bus communication. Check if more than 2 adjacent electronic modules are pulled. Relevant modules are located between gateway and this module.
	RED	FLASHING (0.5 Hz)	Upcoming module diagnostics
DI channels		OFF	Input status x = 0 (OFF)
0...7	GREEN	ON	Input status x = 1 (ON)

Note:

The numbering of the LEDs corresponds to the numbering of the channels.

Data mapping

DATA	BYTE	Bit 7	Bit 6	Bit 5	Bit 4	Bit 3	Bit 2	Bit 1	Bit 0
Input	n	DI 7	DI 6	DI 5	DI 4	DI 3	DI 2	DI 1	DI 0

n = Offset of input data; depending on extension of station and the corresponding fieldbus.

m = Offset of output data; depending on extension of station and the corresponding fieldbus.

With PROFIBUS, PROFINET and CANopen, the I/O data of this module is localized within the process data of the whole station via the hardware configuration tool of the fieldbus master.

With DeviceNet™, EtherNet/IP™ and Modbus TCP a detailed mapping table can be created with the TURCK configuration tool I/O-ASSISTANT.

Pin assignment at corresponding base module:

DATA	BYTE	Bit 7	Bit 6	Bit 5	Bit 4	Bit 3	Bit 2	Bit 1	Bit 0
------	------	-------	-------	-------	-------	-------	-------	-------	-------

BL67-B-8M8

Input	n	C7 P4	C6 P4	C5 P4	C4 P4	C3 P4	C2 P4	C1 P4	C0 P4
-------	---	-------	-------	-------	-------	-------	-------	-------	-------

BL67-B-4M12

Input	n	C3 P2	C2 P2	C1 P2	C0 P2	C3 P4	C2 P4	C1 P4	C0 P4
-------	---	-------	-------	-------	-------	-------	-------	-------	-------

BL67-B-4M12-P

Input	n	C3 P2	C3 P4	C2 P2	C2 P4	C1 P2	C1 P4	C0 P2	C0 P4
-------	---	-------	-------	-------	-------	-------	-------	-------	-------

BL67-B-1M23(-VI)

Input	n	C0 P8	C0 P7	C0 P6	C0 P5	C0 P4	C0 P3	C0 P2	C0 P1
-------	---	-------	-------	-------	-------	-------	-------	-------	-------

C... = slot no., P... = pin no.