

# BL67 electronic module

## 4 Digital Inputs, Channel Diagnostics, 4 Digital Outputs, PNP, 0.5 A

### BL67-4DI4DO-PD

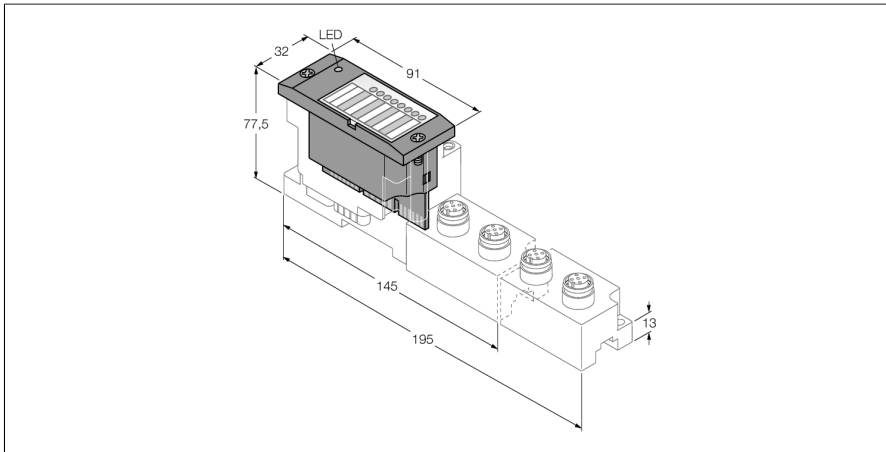

- Independent of the fieldbus and connection technology used
- Protection class IP67
- LEDs indicate status and diagnostic
- Electronics galvanically separated from the field level via optocouplers
- 4 digital inputs, 24 VDC
- 4 digital outputs, 24 VDC, max. 0.5 A
- PNP switching
- Channel diagnostics
- Adjustable filter times
- Invertible inputs

Type	BL67-4DI4DO-PD
ID	6827203
Number of channels	8
Supply voltage	24 VDC
Nominal voltage $V_o$	24 VDC
Nominal current from field supply	$\leq 100$ mA
Nominal current from module bus	$\leq 30$ mA
Max. sensor supply $I_{\text{sens}}$	100 mA For 2 channels ( $\Rightarrow$ e.g. per M12 slot), electronically limited current supply
max. load current $I_o$	10 A via gateway or power feed
Power dissipation, typical	$\leq 1.5$ W

Input type	PNP
Type of input diagnostics	channel diagnostics
Low-level signal voltage	$< 4.5$ V
High level signal voltage	7...30 V
Low level signal current	$< 1.5$ mA
High level signal current	2.1...3.7 mA
Input delay	0.25; 2.5 ms
Electrical isolation	electronics for the field level
Output connectivity	M8, M12, M23

Output type	PNP
Output voltage	24 VDC
Output current per channel	0.5 A
Output delay	3 ms
Load type	resistive, inductive, lamp load
Load resistance, resistive	$> 48$ $\Omega$
Load resistance, inductive	$< 1.2$ H
Lamp load	$< 3$ W
Switching frequency, resistive	$< 200$ Hz
Switching frequency, inductive	$< 2$ Hz
Switching frequency, lamp load	$< 20$ Hz
Electrical isolation	electronics for the field level

#### Functional principle

BL67 electronic modules are plugged into the purely passive base modules which are needed for connection of field devices. The separation of connection level and electronics simplifies maintenance considerably. Flexibility is enhanced because the user can choose between base modules with different connection technologies.

The electronic modules are completely independent of the higher level fieldbus through the use of gateways.

#### Note

The inputs and outputs of the digital combi-module are supplied via a common GND. Therefore, we recommend **not** to use this module for safety or emergency stop applications.



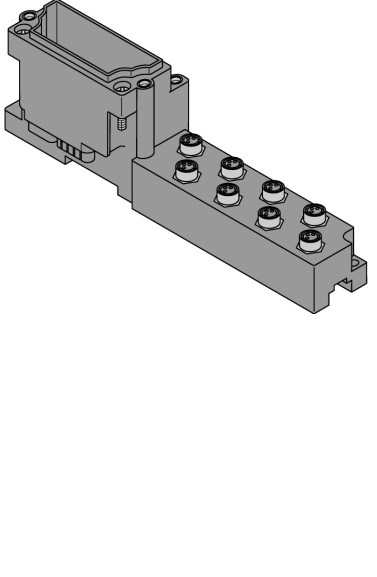
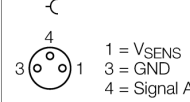
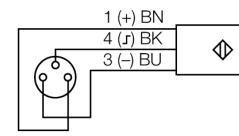
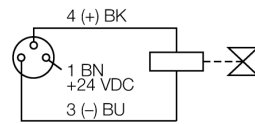
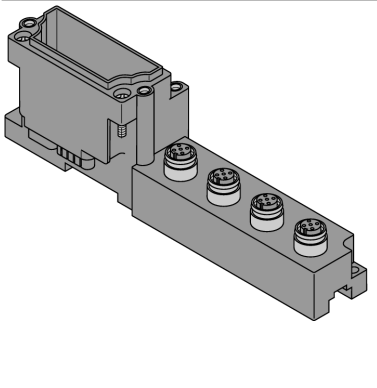
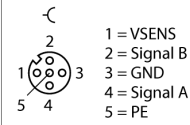
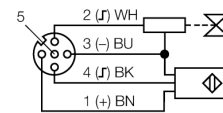
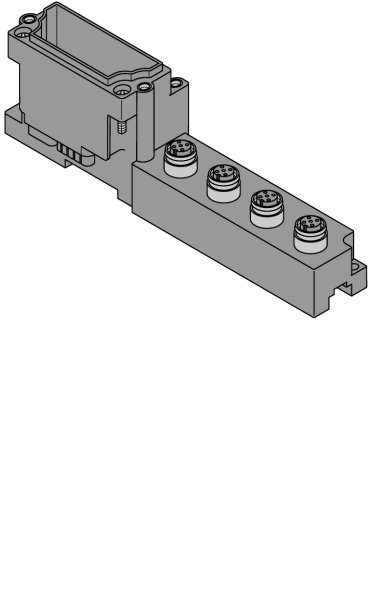
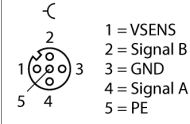
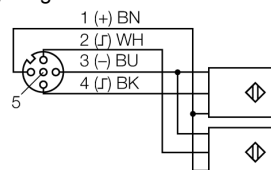
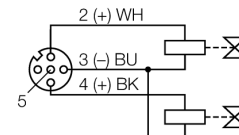

Otherwise, it must be ensured that  $V_i$  and  $V_o$  at the gateway or power feeding module are all-pole disabled.

Number of diagnostic bits	8
Number of parameter bytes	4
Dimensions (W x L x H)	32 x 91 x 59 mm
Approvals	CE
Ambient temperature	-40...+70 °C
Temperature derating	
< 0 °C Ambient temperature	Support for version VN 01-03 and higher, no limitation
Storage temperature	-40...+85 °C
Relative humidity	5...95 % (internal), level RH-2, no condensation (when stored at 45 °C)
Vibration test	Acc. to EN 61131
- up to 5 g (at 10 to 150 Hz)	for mounting on DIN rail no drilling according to EN 60715, with end bracket
- up to 20 g (at 10 up to 150 Hz)	for mounting on base plate or machinery Therefore every second module has to be mounted with two screws each.
Shock test	Acc. to IEC 60068-2-27
Drop and topple	acc. to IEC 68-2-31 and free fall to IEC 68-2-32
Electromagnetic compatibility	Acc. to EN 61131-2
Protection class	IP67
Tightening torque fixing screw	0.9...1.2 Nm

## Compatible base modules

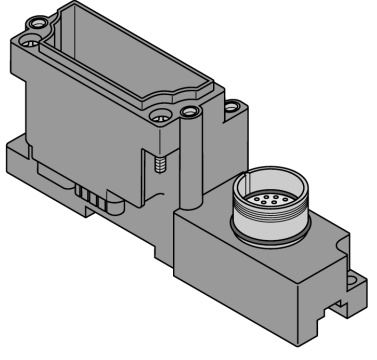
Dimension drawing	Type	Pin configuration
	<p><b>BL67-B-8M8</b> 6827188 8 x M8, 3-pole, female</p> <p><b>Comments</b> Matching connection cable (for example): PKG3M-2-PSW3M/TXL Ident-No. 6625668</p>	<p><b>Pin Assignment</b></p>  <p>1 = VSSENS 3 = GND 4 = Signal A</p> <p><b>Wiring Diagram Ports 0 to 3</b></p>  <p>1 (+) BN 4 (J) BK 3 (-) BU</p> <p><b>Connection diagram, port 4 to 7</b></p>  <p>4 (+) BK 1 BN +24 VDC 3 (-) BU</p>
	<p><b>BL67-B-4M12</b> 6827187 4 x M12, 5-pole, female</p> <p><b>Comments</b> Matching connection cable (for example): RKC4.4T-2-RSC4.4T/TXL Ident-No. 6625608 Possible applications Triggering light screen Pick To Light for work sequence control</p>	<p><b>Pin Assignment</b></p>  <p>1 = VSSENS 2 = Signal B 3 = GND 4 = Signal A 5 = PE</p> <p><b>Wiring Diagram Ports 0 to 3</b></p>  <p>2 (J) WH 3 (-) BU 4 (J) BK 1 (+) BN</p>
	<p><b>BL67-B-4M12-P</b> 6827195 4 x M12, 5-pole, female, paired</p> <p><b>Comments</b> Matching connection cable (for example): RKC4.4T-2-RSC4.4T/TXL Ident-No. 6625608</p>	<p><b>Pin Assignment</b></p>  <p>1 = VSSENS 2 = Signal B 3 = GND 4 = Signal A 5 = PE</p> <p><b>Wiring Diagram Ports 0 and 1</b></p>  <p>1 (+) BN 2 (J) WH 3 (-) BU 4 (J) BK</p> <p><b>Wiring diagram port 2 and 3</b></p>  <p>2 (+) WH 3 (-) BU 4 (+) BK</p>

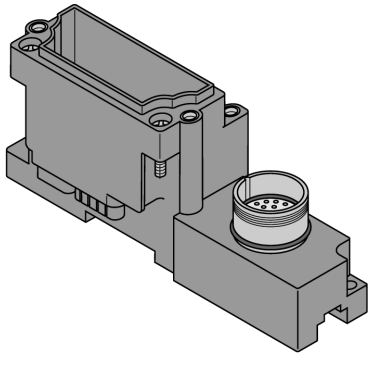
## Compatible base modules

Dimension drawing	Type	Pin configuration												
	<p><b>BL67-B-1M23-VI</b> 6827290 1 x M23, 12-pole, female</p> <p><b>Comments</b> Matching connection cable (for example): FW-M23ST12Q-G-LT-ME-XX-10 Ident no. 6604070</p>	<p><b>Pin Assignment</b></p>  <table border="0"> <tr> <td>1 = Signal 0</td> <td>7 = Signal 6</td> </tr> <tr> <td>2 = Signal 1</td> <td>8 = Signal 7</td> </tr> <tr> <td>3 = Signal 2</td> <td>9 = V<sub>SENS</sub></td> </tr> <tr> <td>4 = Signal 3</td> <td>10 = V<sub>SENS</sub></td> </tr> <tr> <td>5 = Signal 4</td> <td>11 = V<sub>SENS</sub></td> </tr> <tr> <td>6 = Signal 5</td> <td>12 = GND</td> </tr> </table>	1 = Signal 0	7 = Signal 6	2 = Signal 1	8 = Signal 7	3 = Signal 2	9 = V <sub>SENS</sub>	4 = Signal 3	10 = V <sub>SENS</sub>	5 = Signal 4	11 = V <sub>SENS</sub>	6 = Signal 5	12 = GND
1 = Signal 0	7 = Signal 6													
2 = Signal 1	8 = Signal 7													
3 = Signal 2	9 = V <sub>SENS</sub>													
4 = Signal 3	10 = V <sub>SENS</sub>													
5 = Signal 4	11 = V <sub>SENS</sub>													
6 = Signal 5	12 = GND													
	<p><b>BL67-B-1M23-PC</b> 6827235 1 x M23, 12-pole, female</p> <p><b>Comments</b> Possible applications: Control of DE-STA-CO electric power clamps. This base module features a special pin configuration allowing the connection of electric clamps with a standard 12-pole M23 connection cable.</p>	<p><b>Pin Assignment</b></p>  <table border="0"> <tr> <td>1 = DO 0</td> <td>7 = GND</td> </tr> <tr> <td>2 = DO 1</td> <td>8 = V<sub>I</sub></td> </tr> <tr> <td>3 = DO 2</td> <td>9 = n.c.</td> </tr> <tr> <td>4 = DI 0</td> <td>10 = GND</td> </tr> <tr> <td>5 = DI 1</td> <td>11 = V<sub>O</sub></td> </tr> <tr> <td>6 = n.c.</td> <td>12 = n.c.</td> </tr> </table>	1 = DO 0	7 = GND	2 = DO 1	8 = V <sub>I</sub>	3 = DO 2	9 = n.c.	4 = DI 0	10 = GND	5 = DI 1	11 = V <sub>O</sub>	6 = n.c.	12 = n.c.
1 = DO 0	7 = GND													
2 = DO 1	8 = V <sub>I</sub>													
3 = DO 2	9 = n.c.													
4 = DI 0	10 = GND													
5 = DI 1	11 = V <sub>O</sub>													
6 = n.c.	12 = n.c.													

**LED display**

<b>LED</b>	<b>Color</b>	<b>Status</b>	<b>Meaning</b>
D		OFF	No error message or diagnostics active.
	RED	ON	Failure of module bus communication. Check if more than 2 adjacent electronic modules are pulled. Relevant modules are located between gateway and this module.
	RED	FLASHING (0.5 Hz)	Upcoming module diagnostics
DI/DO channels 0...7		OFF	Status channel x = 0 (OFF), no active diagnostics
	GREEN	ON	Status channel x = 1 (ON)
	RED	ON	Short-circuit at output
	RED	FLASHING (2 Hz)	Short-circuit sensor supply

## Data mapping

DATA	BYTE	Bit 7	Bit 6	Bit 5	Bit 4	Bit 3	Bit 2	Bit 1	Bit 0
Input	n	-	-	-	-	DI 3	DI 2	DI 1	DI 0
Output	m	-	-	-	-	DO 3	DO 2	DO 1	DO 0

n = Offset of input data; depending on extension of station and the corresponding fieldbus.

m = Offset of output data; depending on extension of station and the corresponding fieldbus.

With PROFIBUS, PROFINET and CANopen, the I/O data of this module is localized within the process data of the whole station via the hardware configuration tool of the fieldbus master.

With DeviceNet™, EtherNet/IP™ and Modbus TCP a detailed mapping table can be created with the TURCK configuration tool I/O-ASSISTANT.

## Pin assignment at corresponding base module:

DATA	BYTE	Bit 7	Bit 6	Bit 5	Bit 4	Bit 3	Bit 2	Bit 1	Bit 0
------	------	-------	-------	-------	-------	-------	-------	-------	-------

### BL67-B-8M8

Input	n	-	-	-	-	C3 P4	C2 P4	C1 P4	C0 P4
Output	m	-	-	-	-	C7 P4	C6 P4	C5 P4	C4 P4

### BL67-B-4M12

Input	n	-	-	-	-	C3 P4	C2 P4	C1 P4	C0 P4
Output	m	-	-	-	-	C3 P2	C2 P2	C1 P2	C0 P2

### BL67-B-4M12-P

Input	n	-	-	-	-	C1 P2	C1 P4	C0 P2	C0 P4
Output	m	-	-	-	-	C3 P2	C3 P4	C2 P2	C2 P4

### BL67-B-1M23(-VI)

Input	n	-	-	-	-	C0 P4	C0 P3	C0 P2	C0 P1
Output	m	-	-	-	-	C0 P8	C0 P7	C0 P6	C0 P5

### BL67-B-1M23-PC

Input	n	-	-	-	-	-	-	C0 P5	C0 P4
Output	m	-	-	-	-	-	C0 P3	C0 P2	C0 P1

C... = slot no., P... = pin no.