

CODESYS 3 Programmable Gateway for the BL20 I/O System

Multiprotocol Ethernet Gateway for PROFINET, EtherNet/IP and Modbus TCP

BL20-PG-EN-V3

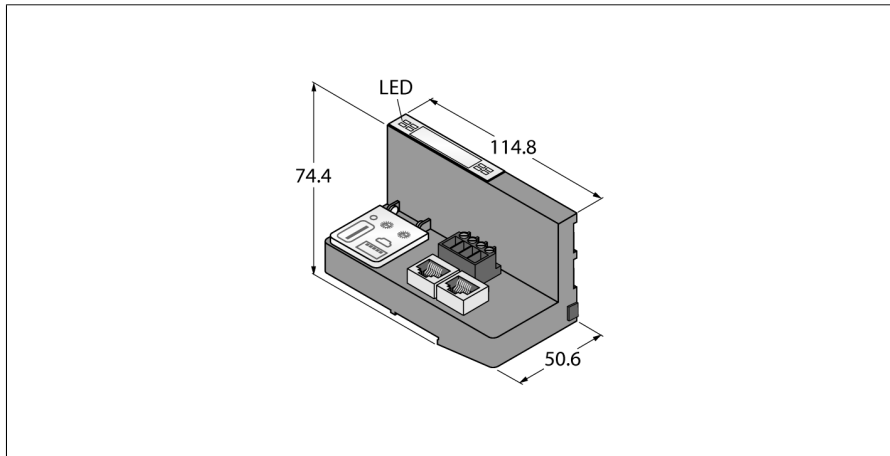

- Programmable multiprotocol Ethernet gateway for PROFINET, EtherNet/IP and Modbus TCP
- OPC-Server
- CODESYS V3 programmable acc.to IEC 61131-3
- Ethernet and USB programming interface
- Protection class IP20
- Integrated power supply
- LEDs for display of PLC status, supply voltage, group and bus errors
- Integrated Ethernet switch allows line topology
- 2 x RJ45 ports, Ethernet fieldbus connection

Type designation	BL20-PG-EN-V3
Ident no.	6827393
Supply voltage	
System power supply	24 VDC
Field supply	24 VDC / 5 VDC
Admissible range	24 VDC
Nominal current from module bus	18...30 VDC
Max. field supply current	≤ 200 mA
Max. system supply current	8 A
Voltage supply connection	1.3 A
	Screw terminals
Fieldbus addressing	
Fieldbus connection technology	Rotary switch, PGM, DHCP RJ45 port
PLC data	
Programming	CODESYS V3
Released for CODESYS version	V 3.5.12.10
Programming languages	IEC 61131-3 (IL, LD, FBD, SFC, ST)
Application tasks	5
Programming interface	Ethernet, USB
Processor	ARM, 32 bit
Cycle time	< 1 ms for 1000 IL commands (without I/O cycle)
Real time clock	yes
Program memory	1024 kByte
Data memory	512 kByte
Input data	4 kByte
Output data	4 kByte
Non-volatile memory	16 kByte
Transmission rate	
	10/100 Mbps; full/half duplex; auto negotiation; auto crossing
Web server	192.168.1.254 (default)
Service interface	Ethernet, mini USB
Modbus TCP	
Addressing	Static IP, DHCP
Supported function codes	FC1, FC2, FC3, FC4, FC5, FC6, FC15, FC16, FC23
Input Data Size	max. 1024 register
Input register start address	0 (0x0000 hex)
Output Data Size	max. 1024 register
Output register start address	0 (0x0000 hex)
Ethernet/IP	
Addressing	acc. to EtherNet/IP specification
Device Level Ring (DLR)	not supported
Input Data Size	248 INT
Output Data Size	248 INT

Functional principle

The programmable BL20 gateways can be used as autonomous PLCs or as decentral PLCs in a network interconnection for a fast preprocessing of signals.

BL20 gateways are the head component of a BL20 station. The BL20 extension modules communicate over the internal module bus with the gateway and can be configured independently of the fieldbus protocol.

CODESYS 3 Programmable Gateway for the BL20 I/O System

Multiprotocol Ethernet Gateway for PROFINET, EtherNet/IP and Modbus TCP

BL20-PG-EN-V3

PROFINET

Addressing	DCP
Conformance class	B (RT)
MinCycleTime	1 ms
Diagnostics	acc. to PROFINET alarm handling
Topology detection	supported
Automatic addressing	supported
Media Redundancy Protocol (MRP)	not supported
Input Data Size	max. 512 BYTE
Output Data Size	max. 512 BYTE







Dimensions (W x L x H)

Dimensions (W x L x H)	50.6 x 114.8 x 74.4mm
Approvals	CE, cULus, Zone 2, Class I, Div. 2
Operating temperature	-20...+60 °C
Storage temperature	-25...+70 °C
Relative humidity	15 to 95% (internal), Level RH-2, no condensation (at 45 °C storage)
Vibration test	acc. to EN 61131
Shock test	acc. to IEC 68-2-27
Drop and topple	acc. to IEC 68-2-31 and free fall to IEC 68-2-32
Electromagnetic compatibility	acc. to EN 61131-2
Protection class	IP20
MTTF	147 years acc. to SN 29500 (Ed. 99) 20 °C

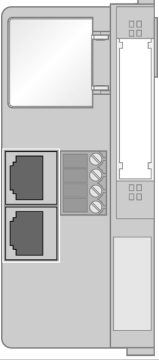
Included in delivery

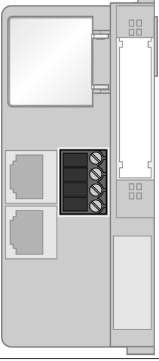
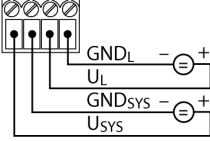
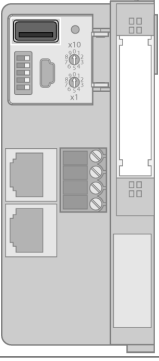
2 x end brackets BL20-WEW-35/2-SW, 1 x end plate
BL20-ABPL

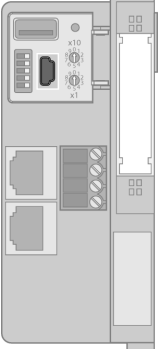
CODESYS 3 Programmable Gateway for the BL20 I/O System
Multiprotocol Ethernet Gateway for PROFINET, EtherNet/IP and Modbus TCP
BL20-PG-EN-V3

	<p>Ethernet Ports</p> <p>The RJ45 Ethernet ports are used as interfaces for programming, configuration and fieldbus communication. The gateway can be operated as a slave at PLCs or PC based systems with PROFINET, EtherNet/IP™ or Modbus TCP master as well as with a driver software.</p> <p>Ethernet Cable (Example): RJ45 - RJ45: RJ45S-RJ45S-441-2M (ID number 6932517) RJ45 – Receptacle: RJ45-FKSDD-441-0,5M/S2174 (ID number 6914221)</p>	<p>Pin Assignment</p>  <p>1 = TX + 2 = TX - 3 = RX + 4 = n.c. 5 = n.c. 6 = RX - 7 = n.c. 8 = n.c.</p>
	<p>Power Supply</p> <p>The BL20 system is supplied with power via a dual-circuit System supply_{sys}</p> <p>U_{sys} is used for the internal system supply at the backplane bus (V_{MB(BV)})</p> <p>Load voltage U_L</p> <p>U_L is for the field supply and should not exceed 8 A.</p>	<p>Pin Assignment</p>  <p>Field supply System supply</p>
	<p>USB Host Port</p> <p>Storage media can be connected to the USB host port, please observe the instructions in the user manual.</p>	<p>Pin Assignment</p>  <p>1 = 5 VDC 2 = D - 3 = D + 4 = GND</p>
	<p>USB Device Port</p> <p>The USB device port can be used as a programming and service interface.</p>	<p>Pin Assignment</p>  <p>1 = 5 VDC 2 = D - 3 = D + 4 = n.c. 5 = GND</p>

CODESYS 3 Programmable Gateway for the BL20 I/O System

Multiprotocol Ethernet Gateway for PROFINET, EtherNet/IP and Modbus TCP

BL20-PG-EN-V3

LED display

LED	Color	Status	Meaning
IOs		OFF	No or too low power supply
	RED	ON	Hardware failure, the firmware is not running
	RED	FLASHING (1Hz)	Incorrect module configuration, actual module configuration does not match the projected configuration
	RED	FLASHING (4 Hz)	No communication to the local I/Os (backplane bus)
	RED/GREEN	FLASHING	Actual module configuration differs from the configured, but can be run
	GREEN	ON	Module bus without errors, actual station configuration matches the configured
	GREEN	FLASHING (1Hz)	DTM force mode active
GW		OFF	No or too low power supply
	RED	FLASHING (1Hz)	Wink command
	GREEN	ON	Gateway without error
BUS		OFF	No or too low power supply
	RED	ON	IP-address conflict or Restore Mode/F_Reset Mode
	RED/GREEN	FLASHING	Autonegotiation and/or DHCP/ BootP waiting for assignment of IP address
	GREEN	ON	Connection established to PLC
	GREEN	FLASHING	Ready
ERR		OFF	No diagnosis
	RED	ON	Diagnosis of the gateway or an I/O module
RUN		OFF	No or too low power supply
	RED	ON	PLC program stopped
	RED	FLASHING	No PLC program available
	GREEN	ON	PLC program running
APPL	RED/GREEN		This LED is controlled user-defined from the CODESYS program
LNK1/LNK2		OFF	No Ethernet link
	YELLOW	ON	Ethernet Link (10 Mbps)
	YELLOW	FLASHING	Ethernet communication (10 Mbps)
	GREEN	ON	Ethernet Link (100 Mbps)
	GREEN	FLASHING	Ethernet communication (100 Mbps)

CODESYS 3 Programmable Gateway for the BL20 I/O System

Multiprotocol Ethernet Gateway for PROFINET, EtherNet/IP and Modbus TCP

BL20-PG-EN-V3

Function accessories

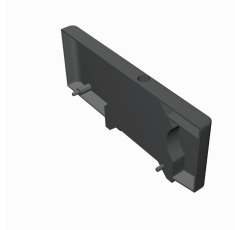
Type code	Ident no.	Description	Dimension drawing
BL20-LABEL-SCHEIBE (5 PCS.)	6827070	Labels for standard electronic modules , DIN A5 sheets, perforated, laser printing, 5 x 37 labels	
BL20-ABPL (2 PCS.)	6827123	End plate for a BL20 station after the last I/O module (2 pieces)	
BL20-WEW-35/2-SW (10 PCS.)	6827124	End bracket for fixation of a BL20 station (10 pieces)	