

TS-500-2UPN8X-H1141

Temperature Detection – 2 PNP/NPN Transistor Switching Outputs

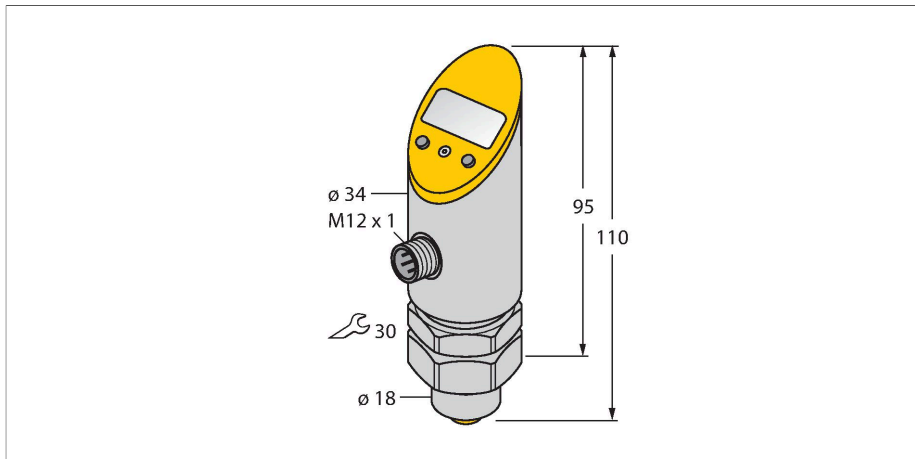

Technical data

Type	TS-500-2UPN8X-H1141
ID	6840018
Temperature range	
Measuring range	-50...500 °C
Measuring range	-58...932 °F
Measuring element	For connection to probes of the TP series
Response time	100 ms
Power supply	
Operating voltage	15...30 VDC
Current consumption	≤ 50 mA
Protective measure	SELV; PELV according to EN 50178
Short-circuit/reverse polarity protection	yes / yes
Insulation class	III
Outputs	
Output 1	Switching output or IO-Link mode
Output 2	Switching output
Switching output	
Communication protocol	IO-Link
Output function	NO/NC programmable, PNP/NPN
Switching point accuracy	± 0.2 K
Rated operational current	0.2 A
Switching frequency	≤ 180 Hz
Release position	-50...+499.8 °C
Switching point	-49.8...+500 °C
Switching point distance	≥ 0.2 K
Switching cycles	≥ 100 mil.

Features

- Housing is rotatable after plugging the process connection
- Reading of adjusted values without tools
- Recessed pushbutton and keylock for secure programming
- Permanent display of temperature unit (°C, °F, K, Ohm)
- Temperature peak memory

Wiring diagram

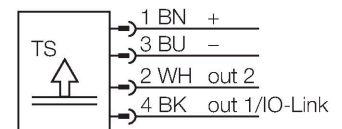

Functional principle

The TS series is a compact processing unit with a 4-digit, 7-segment display. Available are versions with non-rotatable (TS400) or rotatable (TS500) body and various output types.

Technical data

Remark	0.1% of full scale applies to temperatures > +200 °C
Repeatability	0.1 K
IO-Link	
IO-Link specification	V 1.0
Transmission physics	corresponds to 3-wire physics (PHY2)
Frame type	2.2
Transmission rate	COM 2 / 38.4 kbps
Process data width	16 bit
Measured value information	14 bit
Switchpoint information	1 bit
Programming	FDT / DTM
Genauigkeit	± 0.2 K
Included in the SIDI GSDML	Yes
Programming options	switch/release point, hysteresis/window mode, NO/NC; unit
Housing material	Stainless-steel/Plastic, 1.4305 (AISI 303)
Process connection	Cylindrical, Ø 18 mm
Wrench size pressure connection / coupling nut	30
Electrical connection	Connector, M12 × 1
Protection class	IP67
Ambient temperature	-40...+80 °C
Storage temperature	-40...+80 °C
Shock resistance	50 g (11 ms) , acc. to IEC 68-2-27
Vibration resistance	20 g (9...2000 Hz), according to IEC 68-2-6
EMV	EN 61000-4-2 ESD:4 kV CD / 8 kV AD EN 61000-4-3 HF radiated:15 V/m EN 61000-4-4 Burst:2 kV EN 61000-4-5 Surge: 1 kV, 42 Ohm EN 61000-4-6 HF conducted:10 V
Reference conditions acc. to IEC 61298-1	
Temperature	15...+25 °C
Atmospheric pressure	860...1060 hPa abs.
Humidity	45...75 % rel.
Auxiliary power	24 VDC
Display	
Display	4-digit 7-segment display, rotatable by 180°
Switching state	2 × LEDs, Yellow
Unit display	4 x green LED (°C, °F, K, Ohm)
Temperature behaviour	
Temperature coefficient span T _{KS}	± 0.15 % of full scale/10 K

Technical data

Temperature coefficient zero point Tk0	± 0.15 % of full scale/10 K
MTTF	335 years acc. to SN 29500 (Ed. 99) 20 °C

Technical data

Type	TS-500-2UPN8X-H1141
ID	6840018
Temperature range	
Measuring range	-50...500 °C
Measuring range	-58...932 °F
Measuring element	For connection to probes of the TP series
Response time	100 ms
Power supply	
Operating voltage	15...30 VDC
Current consumption	≤ 50 mA
Voltage drop at I _o	≤ 2 V
Protective measure	SELV; PELV according to EN 50178
Short-circuit/reverse polarity protection	yes / yes
Protection type and class	IP67 / III
Outputs	
Output 1	Switching output or IO-Link mode
Output 2	Switching output
Switching output	
Communication protocol	IO-Link
Output function	NO/NC programmable, PNP/NPN
Switching point accuracy	± 0.2 K
Rated operational current	0.2 A
Switching frequency	≤ 180 Hz
Switching point distance	≥ 0.2 K
Switching cycles	≥ 100 mil.
Release position	-50...+499.8 °C
Switching point	-49.8...+500 °C
Remark	0.1% of full scale applies to temperatures > +200 °C
Repeatability	0.1 K
IO-Link	
IO-Link specification	V 1.0
Programming	FDT / DTM
Transmission physics	corresponds to 3-wire physics (PHY2)
Transmission rate	COM 2 / 38.4 kbps
Process data width	16 bit
Measured value information	14 bit

Technical data

Switchpoint information	1 bit
Frame type	2.2
Genauigkeit	± 0.2 K
Included in the SIDI GSDML	Yes
Temperature behaviour	
Temperature coefficient zero point T_{k0}	± 0.15 % of full scale/10 K
Temperature coefficient span T_{ks}	± 0.15 % of full scale/10 K
Ambient conditions	
Ambient temperature	-40...+80 °C
Storage temperature	-40...+80 °C
Vibration resistance	20 g (9...2000 Hz), according to IEC 68-2-6
Shock resistance	50 g (11 ms) , acc. to IEC 68-2-27
EMV	EN 61000-4-2 ESD:4 kV CD / 8 kV AD EN 61000-4-3 HF radiated:15 V/m EN 61000-4-4 Burst:2 kV EN 61000-4-5 Surge: 1 kV, 42 Ohm EN 61000-4-6 HF conducted:10 V
Mechanical data	
Housing material	Stainless-steel/Plastic, 1.4305 (AISI 303)
Process connection	Cylindrical, Ø 18 mm
Wrench size pressure connection / coupling nut	30
Electrical connection	Connector, M12 × 1
Reference conditions acc. to IEC 61298-1	
Temperature	15...+25 °C
Atmospheric pressure	860...1060 hPa abs.
Humidity	45...75 % rel.
Auxiliary power	24 VDC
Display	
Display	4-digit 7-segment display, rotatable by 180°
Switching state	2 × LEDs, Yellow
Unit display	4 x green LED (°C, °F, K, Ohm)
Programming options	switch/release point, hysteresis/window mode, NO/NC; unit
MTTF	335 years acc. to SN 29500 (Ed. 99) 20 °C

Accessories

TP-206A-CF-H1141-L200 9910477

temperature detector for liquid and gaseous media

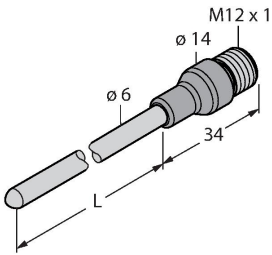

TP-206A-CF-H1141-L100 9910475

temperature detector for liquid and gaseous media

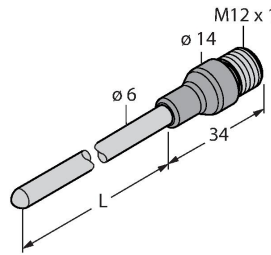

TP-206A-CF-H1141-L150 9910476

temperature detector for liquid and gaseous media

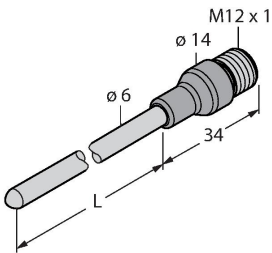

TP-206A-CF-H1141-L300 9910478

temperature detector for liquid and gaseous media

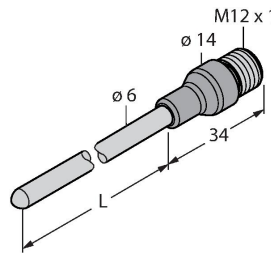

TP-306A-CF-H1141-L1000 9910479

temperature detector for liquid and gaseous media

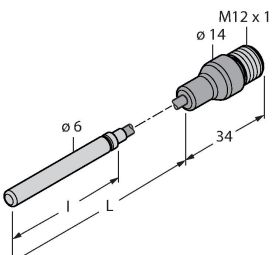

TP-306A-CF-H1141-L2000 9910480

temperature detector for liquid and gaseous media

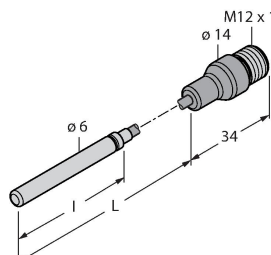

TP-306A-CF-H1141-L5000 9910481

temperature detector for liquid and gaseous media

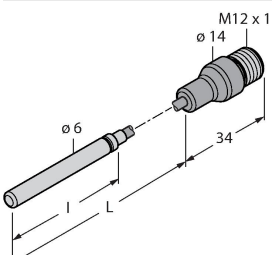

TP-504A-TRI3/4-H1141-L035 9910429

temperature detector for liquid and gaseous media



TP-504A-TRI3/4-H1141-L100 9910430

temperature detector for liquid and gaseous media

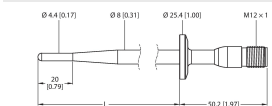

TP-504A-DN25K-H1141-L035 9910431

temperature detector for liquid and gaseous media

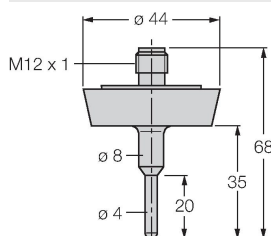

TP-504A-DN25K-H1141-L100 9910432

temperature detector for liquid and gaseous media

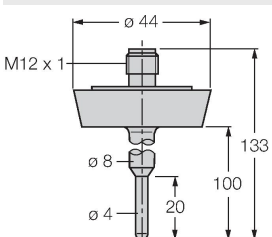

BSS-18 6901320

Mounting clamp for smooth and threaded barrel sensors; material: Polypropylene

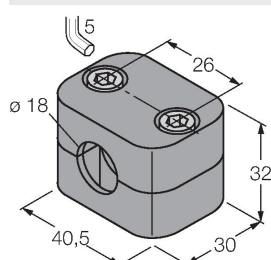

TP-206.35A-CF-H1141-L100

9910819

temperature detector for liquid and gaseous media

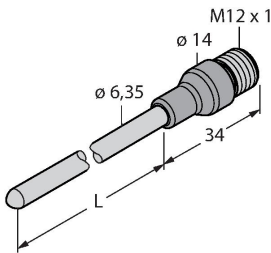

TP-206.35A-CF-H1141-L150

9910820

temperature detector for liquid and gaseous media

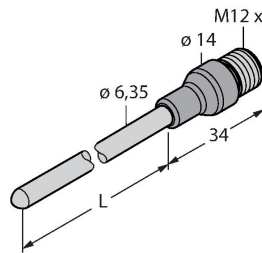

TP-206.35A-CF-H1141-L200

9910821

temperature detector for liquid and gaseous media

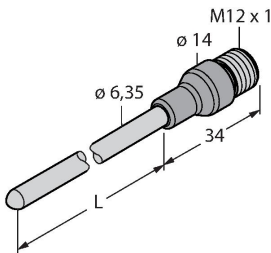

TP-206.35A-CF-H1141-L300

9910822

temperature detector for liquid and gaseous media

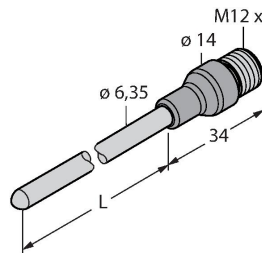

TP-504A-TRI1.5-H1141-L100

9910860

temperature detector for liquid and gaseous media

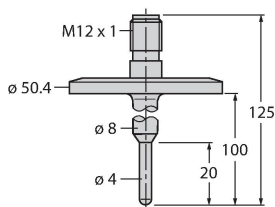

TP-206KK1-CF-H1141-L100

100017085

temperature detector for liquid and gaseous media

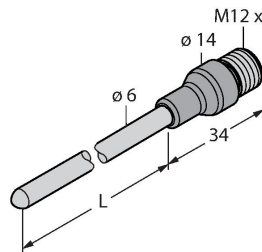

TP-206KK1-CF-H1141-L150

100017084

temperature detector for liquid and gaseous media

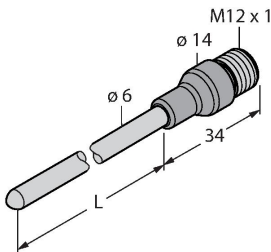

TP-206KK1-CF-H1141-L200

100017083

temperature detector for liquid and gaseous media

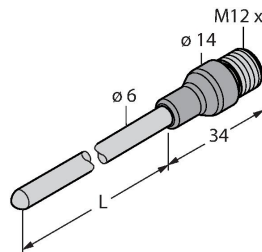

TP-306A-CF-H1141-L5500

100024018

temperature detector for liquid and gaseous media

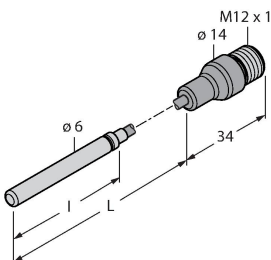

TP-203KK1-CF-H1141-L150

100045292

temperature detector for liquid and gaseous media

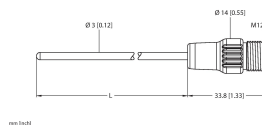

Accessories

Dimension drawing

Type

ID

WKC4.4T-2/TEL

6625025

Connection cable, female M12, angled, 4-pin, cable length: 2 m, sheath material: PVC, black; cULus approval; other cable lengths and qualities available, see www.turck.com

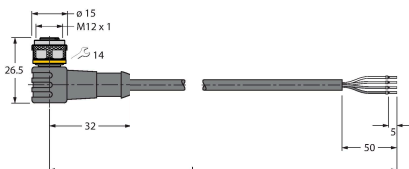

Dimension drawing	Type	ID	
	RKC4.4T-2/TEL	6625013	Connection cable, female M12, straight, 4-pin, cable length: 2 m, sheath material: PVC, black; cULus approval; other cable lengths and qualities available, see www.turck.com
	RKC4.4T-2/TXL	6625503	Connection cable, female M12, straight, 4-pin, cable length: 2 m, sheath material: PUR, black; cULus approval; other cable lengths and qualities available, see www.turck.com
	WKC4.4T-2/TXL	6625515	Connection cable, female M12, angled, 4-pin, cable length: 2 m, sheath material: PUR, black; cULus approval; other cable lengths and qualities available, see www.turck.com
	RKC4.4T-P7X2-10/TXL	6626184	Connection cable, female M12, angled, 4-pin, cable length: 10m, sheath material: PUR, black; cULus approval; other cable lengths and qualities available, see www.turck.com