

Accessories

Mounting Bracket For Flow Sensors FCI-1/4-1/4-1/4-A4

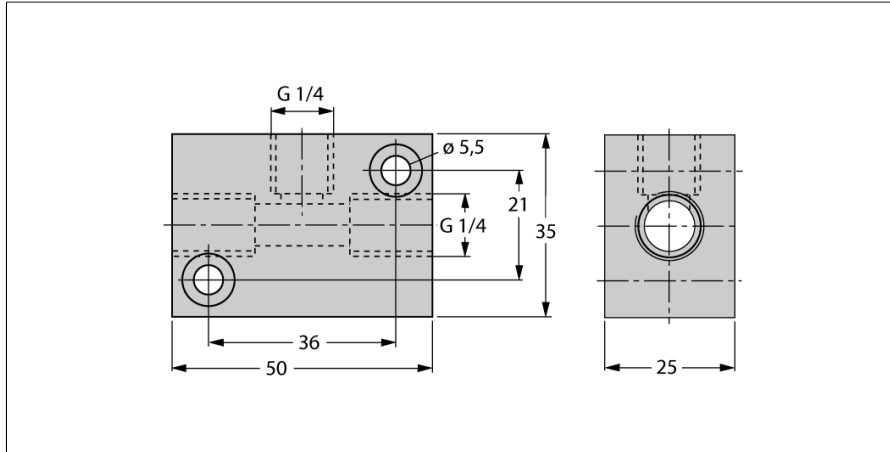

- Mounting bracket for FCS-G1/4 flow sensors
- Stainless steel 1.4571 / AISI 316Ti
- Bulk current 10 ml/min and more

ID	6873012
Type	FCI-1/4-1/4-1/4-A4
Ambient temperature	0...+60 °C
Housing material	Stainless steel, 1.4571 (AISI 316Ti)