

**Accessories**

**Weld-On Plate for Mounting Clamps  
BSS-SPV2**

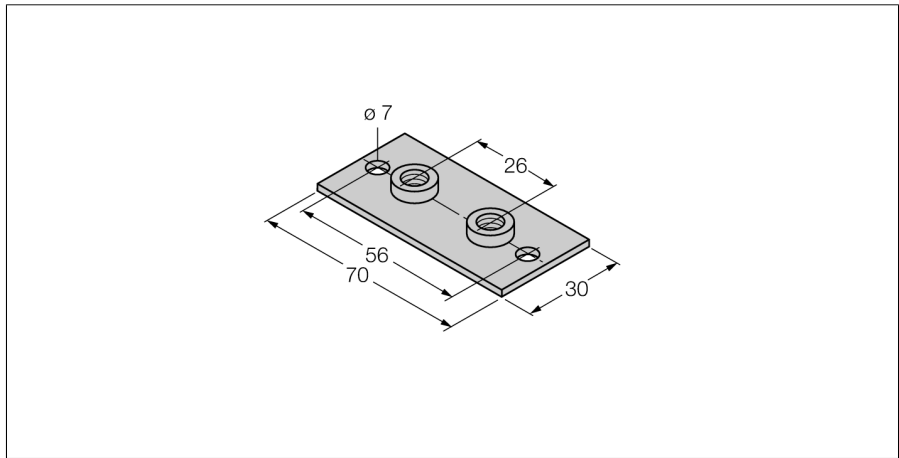

- **Weld-On Plate for Mounting Clamps**
- **Material: Metal, ST 37**

**General description**

The portfolio of mounting brackets consists of two half-shells and two Allen screws each. Optionally welding plates with additional drilling holes can be used. Matching DIN rail nuts are available for the mounting of DIN rails.

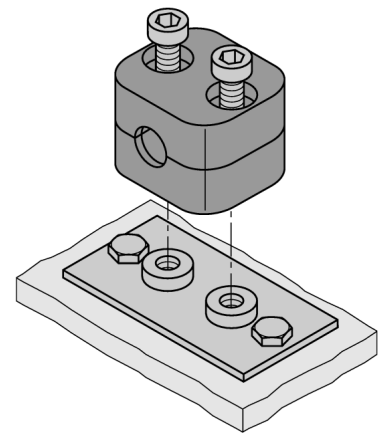

<b>Type designation</b>	BSS-SPV2
Ident no.	6901316
<b>Dimensions</b>	30 x 70 mm
Housing material	Metal, ST 37