

Accessories
Mounting bracket
MW-18

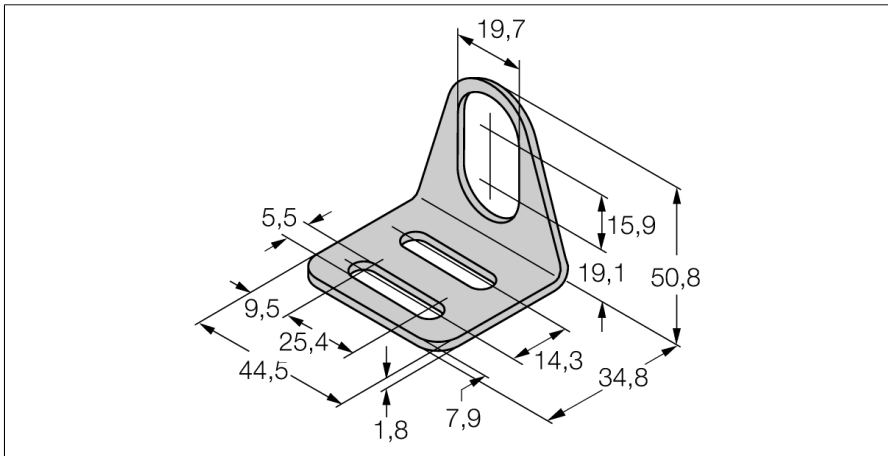

- Mounting bracket for M18 x1 threaded barrel sensors
- Stainless steel A2 1.4301 (AISI 304)

General description

The mounting bracket for the sensor in the threaded barrel M18 x1 provides high flexibility for mounting. The position of the sensor can easily be re-adjusted in all directions and is thus very user friendly.

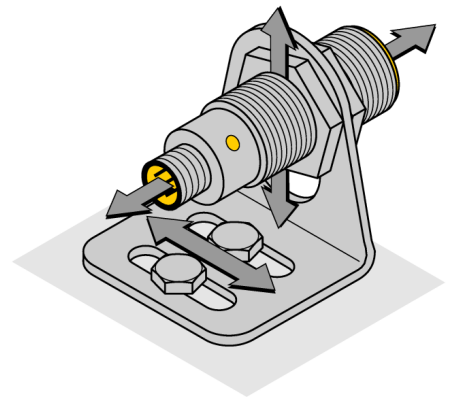

Type designation	MW-18
Ident no.	6945004
Design	Accessories for threaded barrel, M18
Dimensions	44.5 x 34.8 x 50.8 mm
Housing material	Metal, 1.4301 (AISI 304)