

Mounting Accessories

Mounting bracket

MW-08

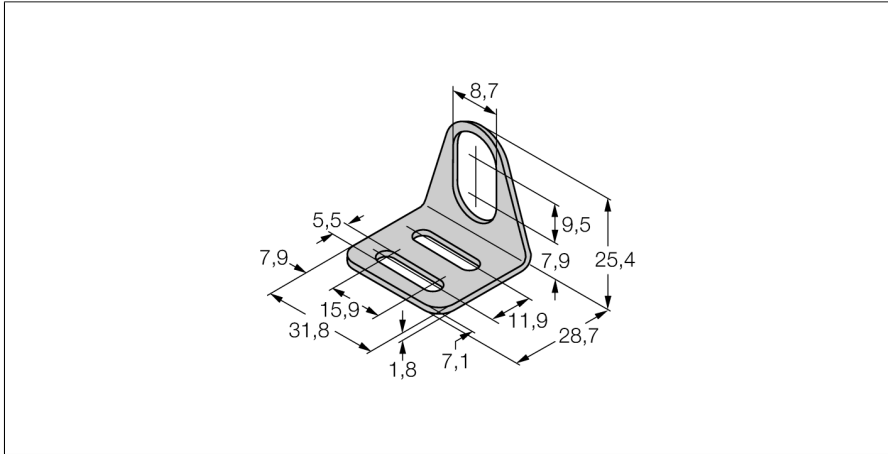

- Mounting bracket for M8 x1 threaded barrel sensors
- Stainless steel A2 1.4301 (AISI 304)

General description

The mounting bracket for the sensor in the threaded barrel M8 x1 provides high flexibility for mounting. The position of the sensor can easily be re-adjusted in all directions and is thus very user friendly.

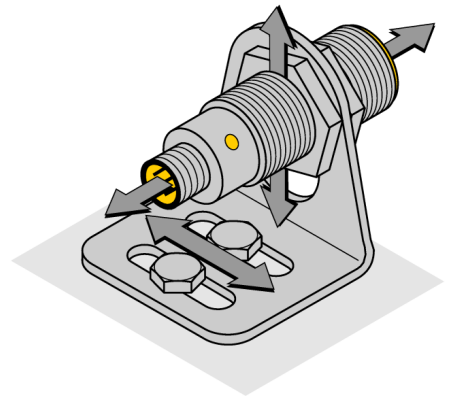

Type	MW08
ID	6945008
Design	Accessories for threaded barrel, M8
Dimensions	28.7 x 31.8 x 25.4 mm
Housing material	Metal, 1.4301 (AISI 304)