

Accessories

Mounting Bracket with Clip Collar

For Round Cylinders, Tie-rod Cylinders

KLR1-ASB1

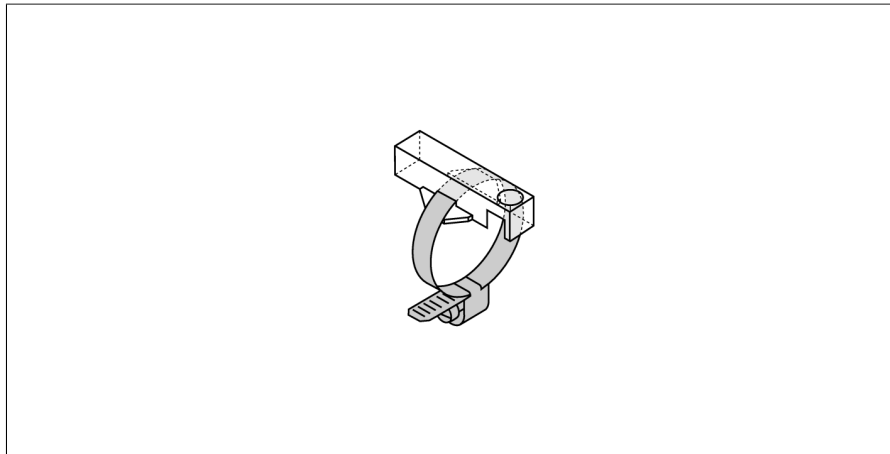

- Mounting on round cylinders
- Cylinder diameter: 7...11 mm
- Plastic: Trogamid

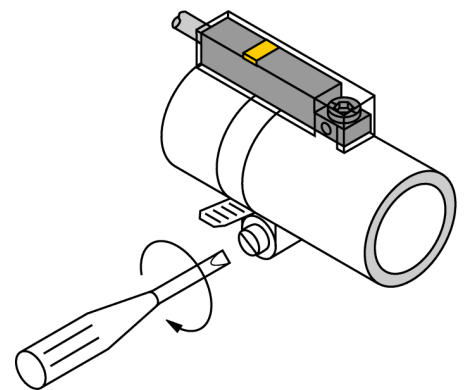

Type	KLR1-ASB1
ID	6970622
Design	Accessories, INT
Dimensions	33 x 15 x 9 mm
Housing material	Plastic, Trogamid
Fixing clamp for correspondent cylinder diameter	7...11 mm