

**Multiprotocol Set in IP67**  
**TI-BL67-EN-8**

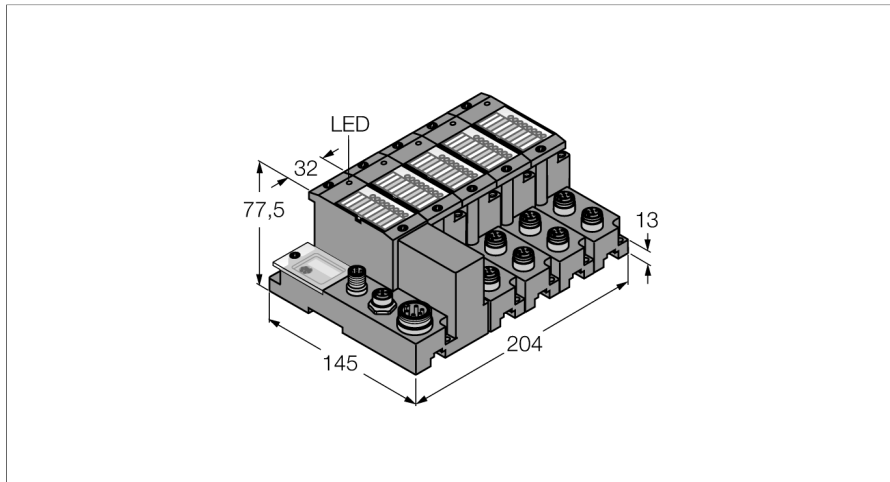

- Connection of up to 8 read/write heads via BL ident M12 extension cables
- Mixed operation of HF and UHF read/write heads

**Power Supply**

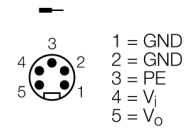

**Wiring Diagram**

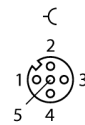

<b>Type designation</b>	TI-BL67-EN-8
Ident no.	7030613
Number of channels	8
Dimensions (W x L x H)	204 x 145 x 77.5 mm
<b>Supply voltage</b>	24 VDC
max. system supply current $I_{mb(SV)}$	1.3, A
Max. sensor supply $I_{sens}$	4 A electronically limited current supply electronically limited current supply
max. load current $I_o$	10 A
Admissible range	18...30 VDC
<b>Service interface</b>	Mini USB, Ethernet
Voltage supply connection	5-pin male 7/8" connector
<b>Transmission rate</b>	115.2 kbps
Electrical isolation	isolation of electronics and field level via opto-couplers
<b>Output connectivity</b>	M12
<b>Sensor supply</b>	0.5 A per channel, short-circuit proof
<b>Temperature derating</b>	&#x0020;
> 55 °C Circulating air (Ventilation)	no limitation
> 55 °C Steady ambient air	$I_{sens} < 3A, I_{mb} < 1A$
Relative humidity	5...95 % (internal), level RH-2, no condensation (when stored at 45 °C)
Vibration test	Acc. to EN 61131
Extended vibration resistance	VN 02-00 and higher
- up to 5 g (at 10 to 150 Hz)	for mounting on DIN rail no drilling according to EN 60715, with end bracket
- up to 20 g (at 10 up to 150 Hz)	for mounting on base plate or machinery Therefore every second module has to be mounted with two screws each.
Shock test	Acc. to IEC 60068-2-27
Drop and topple	acc. to IEC 68-2-31 and free fall to IEC 68-2-32
Electromagnetic compatibility	Acc. to EN 61131-2
Protection class	IP67
<b>Included in delivery</b>	1 x end plate BL67

**Functional principle**

BL67 gateways are the head component of a BL67 station. They are designed to connect the modular fieldbus nodes to the higher-level fieldbus (PROFIBUS-DP, DeviceNet, CANopen, Ethernet Modbus TCP, PROFINET, EtherCAT or EtherNet/IP).

All BL67 electronic modules communicate via the internal module bus, the data of which is transferred to the fieldbus via the gateway. All I/O modules can thus be configured independently of the bus system.

The pin resp. signal assignment results from the combination with an electronic module. You find the pin configuration and the wiring diagrams on the data sheet of the corresponding electronic module.

BL67 base modules are connected to the right of the gateway, using two screws for each module. A DIN rail is not required. This way, a compact and stable unit is built. The unit can now be mounted on a DIN rail or directly on the machine.

The field devices are connected to the base modules which are available with different connection technology (M8, M12, M23 and 7/8" ).

**Note**

Further technical data like temperature range are determined by the electronic modules and can be found on the data sheets.

## Multiprotocol Set in IP67

### TI-BL67-EN-8

BL67 electronic modules are plugged on the purely passive base modules which in turn are connected to the field devices. The separation of connection level and electronics simplifies maintenance considerably. Flexibility is enhanced because the user can choose between base modules with different connection technologies.

The electronic modules are completely independent of the higher level fieldbus through the use of gateways.

BL67 gateways are the head component of a BL67 station. They are designed to connect the modular fieldbus nodes to the higher-level fieldbus (PROFIBUS-DP, DeviceNet, CANopen, Ethernet Modbus TCP, PROFINET, EtherCAT or EtherNet/IP).

All BL67 electronic modules communicate via the internal module bus, the data of which is transferred to the fieldbus via the gateway. All I/O modules can thus be configured independently of the bus system.

**Multiprotocol Set in IP67**  
**TI-BL67-EN-8**

**Pin assignment and supply concept**

	<p><b>Ethernet Ports</b> Starting from version VN 03-00, the gateway features two D-coded M12 Ethernet ports with integrated switch. The ports are used as interfaces for configuration and fieldbus communication. The gateway supports the EtherNet/IP™ and Modbus TCP protocols</p>	<p><b>Pin Assignment</b></p> <p>1 = YE (TX +) 2 = WH (RX +) 3 = OG (TX -) 4 = BU (RX -)</p>
	<p><b>Power Supply</b> Double-tuned power supply of the BL67 system.</p> <p><b>System power supply <math>V_i</math></b> <math>V_i</math> is for the internal system supply at the backplane bus (<math>V_{MB(EV)}</math>) and for the 4A short-circuit limited sensor supply (<math>V_{sens}</math>).</p> <p><b>Load voltage <math>V_o</math></b> <math>V_o</math> for output supply, limited to max. 10A.</p>	<p><b>Pin Assignment</b></p> <p>1 = GND 2 = GND 3 = PE 4 = <math>V_i</math> 5 = <math>V_o</math></p>
	<p><b>Ethernet Ports</b> The ports are used as interfaces for configuration and fieldbus communication. The gateway supports EtherCAT.</p>	<p><b>Pin assignment</b></p> <p>1 = YE (TX +) 2 = WH (RX +) 3 = OG (TX -) 4 = BU (RX -)</p>
	<p><b>Power Supply</b> The BL67 system is supplied with power via two circuits.</p> <p><b>System supply <math>V_i</math></b> <math>V_i</math> is for the internal system supply at the backplane bus (<math>V_{MB(EV)}</math>), and for the sensor supply (<math>V_{sens}</math>) with a short-circuit current limit of 4 A.</p> <p><b>Load voltage <math>V_o</math></b> <math>V_o</math> is for supplying the outputs and is limited to max. 10 A.</p>	<p><b>Pin assignment</b></p> <p>1 = GND 2 = GND 3 = PE 4 = <math>V_i</math> 5 = <math>V_o</math></p>

**Multiprotocol Set in IP67**  
**TI-BL67-EN-8**

**Compatible base modules**

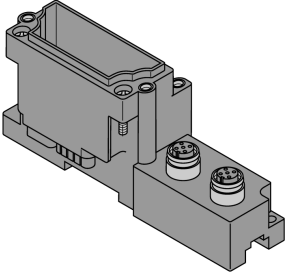
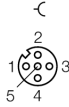
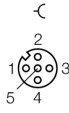
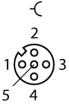
Dimension drawing	Type	Pin configuration
	<p>BL67-B-2M12 6827186 2 x M12, 5-pole, female, a-coded</p>	<p><b>Pin configuration</b></p> <p><b>.../S2500 Connectors</b></p>  <ul style="list-style-type: none"> <li>1 = BN (+)</li> <li>2 = BK (Data)</li> <li>3 = BU (GND)</li> <li>4 = WH (Data)</li> <li>5 = shield</li> </ul> <p><b>.../S2501 Connectors</b></p>  <ul style="list-style-type: none"> <li>1 = BN (+)</li> <li>2 = WH (Data)</li> <li>3 = BU (GND)</li> <li>4 = BK (Data)</li> <li>5 = shield</li> </ul> <p><b>Connectors .../S2503</b></p>  <ul style="list-style-type: none"> <li>1 = RD (+)</li> <li>2 = BU (Data)</li> <li>3 = BK (GND)</li> <li>4 = WH (Data)</li> <li>5 = shield</li> </ul>

## Multiprotocol Set in IP67

### TI-BL67-EN-8

#### LED display

LED	Color	Status	Meaning
D		OFF	No error message or diagnostics active.
	RED	ON	Failure of module bus communication. Check if more than 2 adjacent electronic modules are pulled. Relevant modules are located between gateway and this module.
	RED	FLASHING (0.5 Hz)	Upcoming module diagnostics
RW0 / RW1		OFF	No tag, no active diagnostics
	GREEN	ON	Tag available
	GREEN	FLASHING (2 Hz)	Data exchange with tag enabled
	RED	ON	Read/write head error
	RED	FLASHING (2 Hz)	Short-circuit in the supply line of read/write head