

Isolating switching amplifier 2-channel IMX12-DI01-2S-2T-PR/24VDC/CC

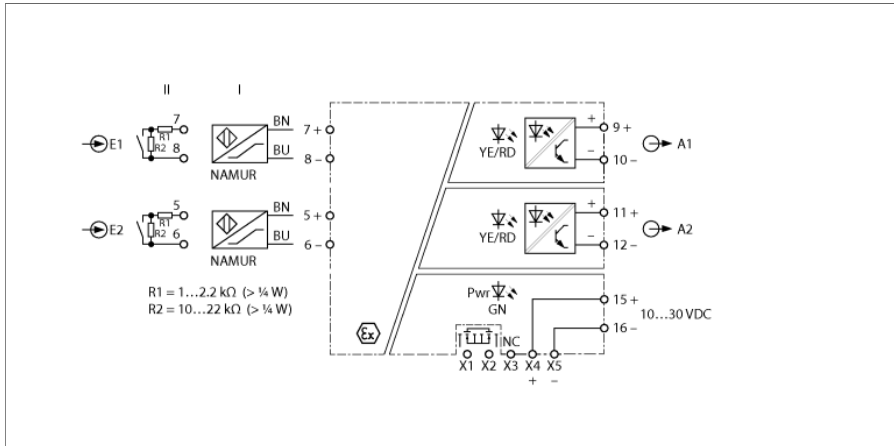

Sensors according to EN 60947-5-6 (NAMUR) or potential-free contacts can be connected to the IMX12-DI01-2S-2T-PR/24VDC/CC isolating switching amplifier. The device is equipped with intrinsically safe input circuits and can be installed in zone 2. A DIP switch allows toggling of the device between 2-channel or 1-channel operating mode with signal doubling. The output circuits are equipped with two potential-free transistors with a high cut-off frequency (10 kHz). The device can be powered from a power bridge that also transmits a collective fault signal. The device complies with the requirements of NE21.

The devices feature DIP switches on the front. This allows to select between the output mode, the input circuit monitoring, as well as toggle between signal duplication and 1-channel operation. When using mechanical contacts, either line monitoring must be switched off or the contact must be wired with resistors (see wiring diagram).

The green LED indicates operational readiness. An error in the input circuit causes the red LED to flash according to NE44. The transistor of the associated output circuit then locks and the common alarm output switches to conductive.

The device can be used in safety circuits up to SIL2 (high and low demand according to IEC 61508).

The device is equipped with removable spring type terminals.

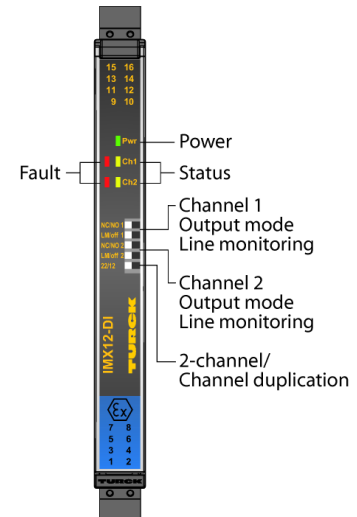

- 2 transistor outputs ($\leq 10\text{kHz}$)
- Switchable: 2-channel or signal doubling
- Output mode adjustable (NO/NC mode)
- Input circuits monitored for wire-break/short-circuit (ON/OFF switchable)
- Complete galvanic isolation
- Input reverse-polarity protected
- Removable spring type terminals
- Power bridge (connector incl. in delivery)
- ATEX, IECEx, NEPSI, cUL, cFM, IN-METRO, Kosha, TIIS, DNV, GL
- Use in Zone 2
- SIL 2

Dimensions

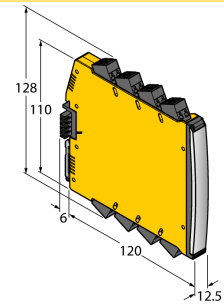

Type	IMX12-DI01-2S-2T-PR/24VDC/CC
ID	7580023
Nominal voltage	24 VDC
Operating voltage	10...30 VDC
Power consumption	≤ 0.8 W
Power dissipation, typical	≤ 0.64 W
Input	2-channel or 1-channel with signal doubling
NAMUR input	
NAMUR	EN 60947-5-6
Input circuit monitoring	on/off switchable
No-load voltage	8.2 VDC
Short-circuit current	8.2 mA
Input resistance	1 kΩ
Cable resistance	≤ 50 Ω
Switch-on threshold	1.75 mA
Switch-off threshold	1.55 mA
Wire breakage threshold	≤ 0.06 mA
Short-circuit threshold	≥ 6.4 mA
Output circuits	
Semiconductor output circuits	
Output circuits (digital)	2 x transistor (potential-free, short-circuit proof)
Switching voltage	≤ 30 VDC
Switching current per output	≤ 0.1 A
Switching frequency	≤ 10000 Hz
Voltage drop	≤ 1.1 V at 20 mA, ≤ 1.8 V at 50 mA, ≤ 2.7 V at 100 mA
Power-Bridge common alarm output	MOSFET, U _{max} = 30 V, I _{max} = 100 mA
Galvanic isolation	
Test voltage	2.5 kV RMS
Input 1 to output 1	375 V peak value acc. to EN 60079-11
Input 2 to output 2	375 V peak value acc. to EN 60079-11
Input 1 to supply	375 V peak value acc. to EN 60079-11
Input 2 to supply	375 V peak value according to EN 60079-11
Output 1 to supply	100 V RMS acc. to EN 50178 and EN 61010-1
Output 2 to supply	100 V RMS acc. to EN 50178 and EN 61010-1
Output 1 to output 2	100 V RMS acc. to EN 50178 and EN 61010-1
Important note	For Ex-applications the values specified in the corresponding Ex certificates (ATEX, IECEx, UL, etc.) apply.
Ex approval acc. to conformity certificate	TÜV 14 ATEX 147004 X
Application area	II (1) G, II (1) D
Ignition protection category	[Ex ia Ga] IIC; [Ex ia Da] IIIC
Application area	II 3 (1) G
Ignition protection type	Ex nA [ia Ga] IIC T4 Gc
Important note	If the device is used in applications to achieve functional safety according to IEC 61508, the safety manual must be used. Information in the data sheet are not valid for functional safety.
Use in SIL safety circuits	SIL 2 acc. to IEC 61508

Displays/Operating elements	
Operational readiness	Green
Switching state	Yellow
Error indication	red

Mechanical data	
Protection class	IP20
Flammability class acc. to UL 94	V-0
Ambient temperature	-25...+70 °C
Storage temperature	-40...+80 °C
Dimensions	120 x 12.5 x 128 mm
Weight	155 g
Mounting instructions	DIN rail (NS35)
Housing material	Polycarbonate/ABS
Electrical connection	Removable spring-type terminals, 2-pin
Connection variant	Power bridge with collective fault signal
Terminal cross-section	0.2...2.5 mm ² (AWG: 24...14)

Environmental conditions	
Operating height	Up to 2000 m above sea level
Pollution degree	II
Surge/Overvoltage category	II (EN 61010-1)
Standards used	
Voltage resistance and insulation	
	EN 50178
	EN 61010-1
	EN 50155
	GL VI-7-2
Shock	
	EN 61373 class B
	EN 50155
	GL VI-7-2
	EN 60068-2-6
	EN 60068-2-27
Temperature	
	EN 60068-2-1 Ad
	EN 50155
	GL VI-7-2
	EN 60068-2-2 Bd
	EN 60068-2-1
Air humidity	
	EN 60068-2-38
EMC	
	EN 50155
	GL VI-7-2
	NE21
	EN 61326-1
	EN 61326-3-1
	EN 61000-4-2
	EN 61000-4-3
	EN 61000-4-4
	EN 61000-4-5
	EN 61000-4-6
	EN 61000-4-11
	EN 61000-4-29
	EN 55011
	EN 55016
	EN 50121-3-2
	EN 61000-6-2

Accessories

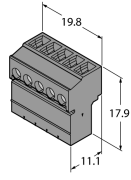
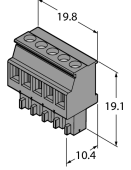
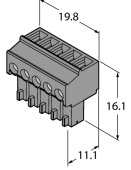
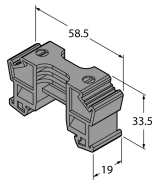
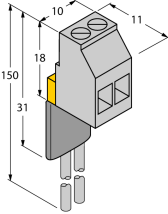
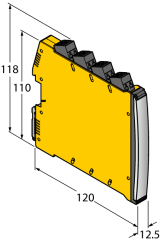
Type code	Ident no.		Dimension drawing
IMC 1.5/ 5-ST-3.81 BK	7580954	Power Bridge Connection Terminal	
MCVR 1.5/ 5-ST-3.81 BK	7580955	Power Bridge Connection Terminal	
MC 1.5/ 5-ST-3.81 BK	7580956	Power Bridge Connection Terminal	
E/ME TBUS NS35 BK	7580957	Power Bridge Connection Terminal	
WM1 WIDER-STANDSMODUL	0912101	The resistor module WM1 meets the requirements for line monitoring between a mechanical contact and a TURCK signal processor. The input circuit of the signal processor is designed for sensors acc. to EN60947-5-6 (NAMUR) and equipped with a wire-break and short-circuit monitoring function.	
IMX12-PS02-UI-UIR-PR/24VDC/CC	7580611	Power supply module power bridge; Collective fault signal via relay; Single and redundant power supply via terminals; Removable screw terminals	

Accessories

Type code	Ident no.		Dimension drawing
IMX12-SC-2X-4BK	7580940	Screw terminals for IM(X)12 modules; included in delivery: 4 pcs. of 2-pin black terminals	
IMX12-SC-2X-4BU	7580941	Screw terminals for IM(X) 12 modules; included in delivery: 4 pcs. of 2-pin blue terminals	
IMX12-CC-2X-4BK	7580942	Spring terminals for IM(X)12 modules; included in delivery: 4 pcs. black terminals, 2-pin	
IMX12-CC-2X-4BU	7580943	Spring terminals for IM(X)12 modules; included in delivery: 4 pcs. blue terminals, 2-pin	