

Accessories

Thermowell

For Temperature Sensors

THW-3-G1/4-A4-L050

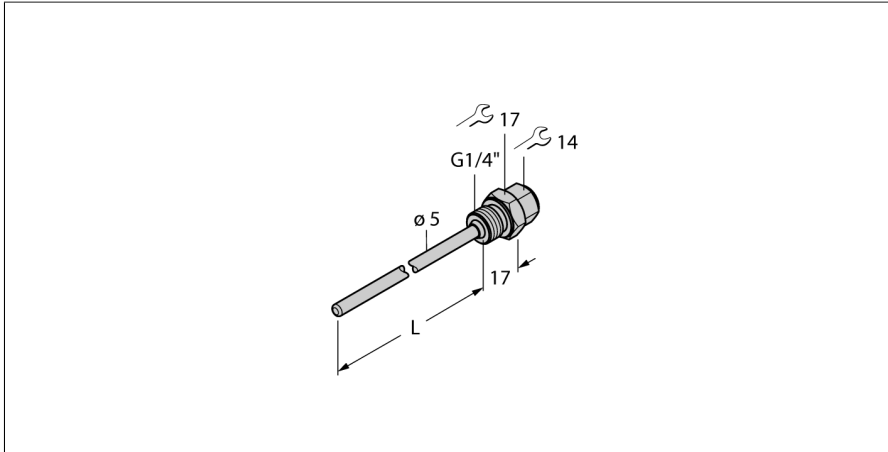

- Thermowell for mounting temperature probes
- End tip diameter 3 mm
- Process connection G1/4" male thread
- Immersion depth 50 mm

General description

Thermowells are used for unpressurized mounting of probes. They protect the probes against direct contact with the medium. The probe can be replaced without interrupting the process.

| | |
|------|--------------------|
| Type | THW-3-G1/4-A4-L050 |
| ID | 9910415 |

| | |
|--------------------------|--------------|
| Temperature range | |
| Measuring range | -50...350 °C |
| Measuring range | -58...662 °F |
| Immersion depth (L) | 50 mm |
| Outer diameter | 5 mm |

| | |
|---------------------------------------|-------------------------------------|
| Mechanical data | |
| Housing material | Stainless steel, 1.4404 (AISI 316L) |
| Internal diameter | 3.1 mm |
| Process connection | G 1/4" male thread |
| Pressure resistance | 400 bar |
| Max. tightening torque of housing nut | 100 Nm |