

# Accessories

## Thermowell

### For Temperature Sensors

#### THW-3-G1/2-A4-L050

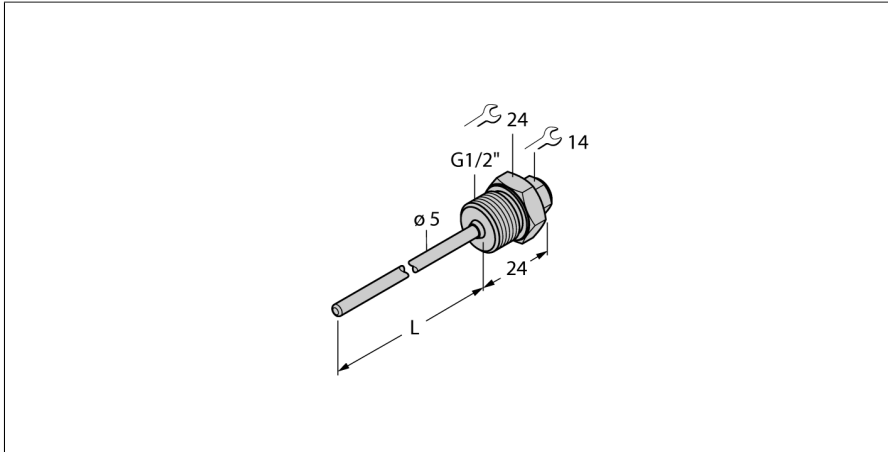

- Thermowell for mounting temperature probes
- End tip diameter 3 mm
- Process connection G1/2" male thread
- Immersion depth 50 mm

**General description**

Thermowells are used for unpressurized mounting of probes. They protect the probes against direct contact with the medium. The probe can be replaced without interrupting the process.

Type	THW-3-G1/2-A4-L050
ID	9910443

<b>Temperature range</b>	
Measuring range	-50...350 °C
Measuring range	-58...662 °F
Immersion depth (L)	50 mm
Outer diameter	5 mm

<b>Mechanical data</b>	
Housing material	Stainless steel, 1.4404 (AISI 316L)
Internal diameter	3.1 mm
Process connection	G 1/2" male thread
Pressure resistance	400 bar
Max. tightening torque of housing nut	100 Nm