

Accessories

Thermowell

For Temperature Sensors

THW-3-N1/2-A4-L050

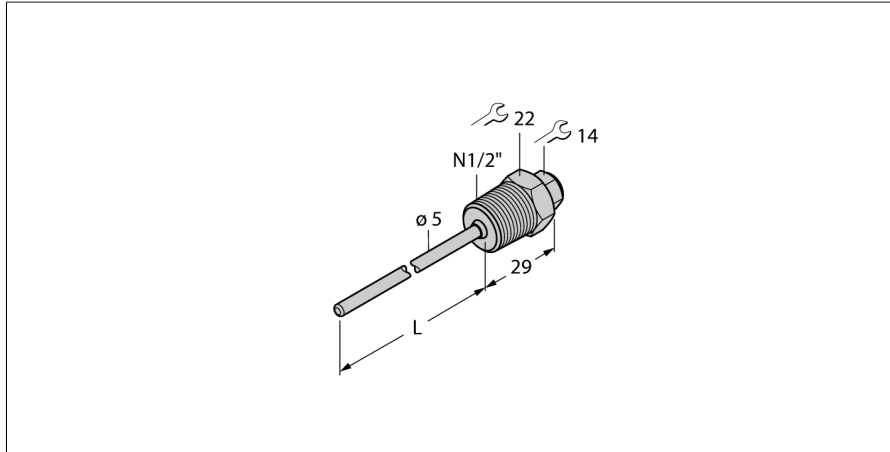

- Thermowell for mounting temperature probes
- End tip diameter 3 mm
- Process connection 1/2" NPT male thread
- Immersion depth 50 mm

General description

Thermowells are used for unpressurized mounting of probes. They protect the probes against direct contact with the medium. The probe can be replaced without interrupting the process.

Type	THW-3-N1/2-A4-L050
ID	9910447

Temperature range	
Measuring range	-50...350 °C
Measuring range	-58...662 °F
Immersion depth (L)	50 mm
Outer diameter	5 mm

Mechanical data	
Housing material	Stainless steel, 1.4404 (AISI 316L)
Internal diameter	3.1 mm
Process connection	1/4" NPT male thread
Pressure resistance	400 bar
Max. tightening torque of housing nut	100 Nm