

Accessories

Thermowell

For Temperature Sensors

THW-3-DN25K-A4-L050

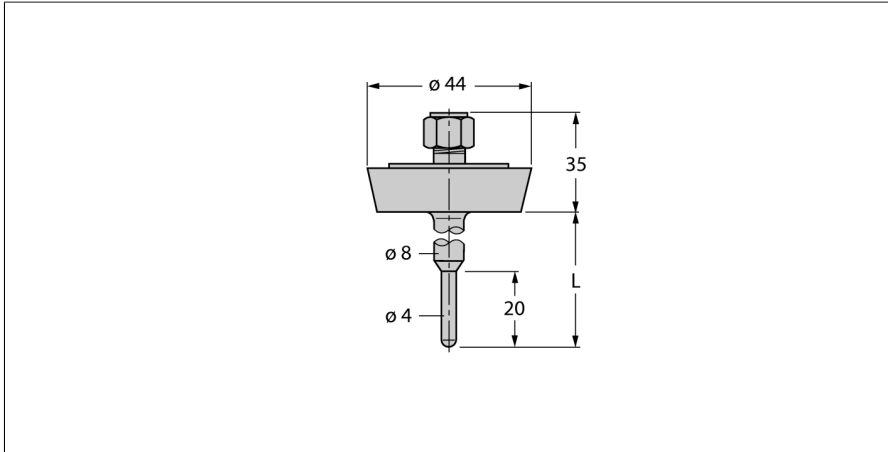

- Thermowell for mounting temperature probes
- End tip diameter 3 mm
- Process connection dairy screw connection DN25 acc. to DIN 11851
- Immersion depth 50 mm
- For use in food and pharmaceutical applications
- Surface roughness Ra > 0.8 µm
- For use in food and pharmaceutical applications
- Surface roughness Ra > 0.8 µm

General description

Thermowells are used for unpressurized mounting of probes. They protect the probes against direct contact with the medium. The probe can be replaced without interrupting the process.

Type	THW-3-DN25K-A4-L050
ID	9910455
Temperature range	
Measuring range	-50...350 °C
Measuring range	-58...662 °F
Immersion depth (L)	50 mm
Outer diameter	4 mm
Mechanical data	
Housing material	Stainless steel, 1.4404 (AISI 316L)
Internal diameter	3.1 mm
Process connection	Threaded tube connection per DIN11851
Pressure resistance	40 bar
Max. tightening torque of housing nut	100 Nm