

TP-206A-CF-H1141-L1000

Temperature Detection – Probe

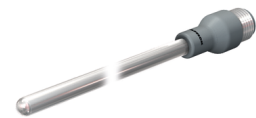
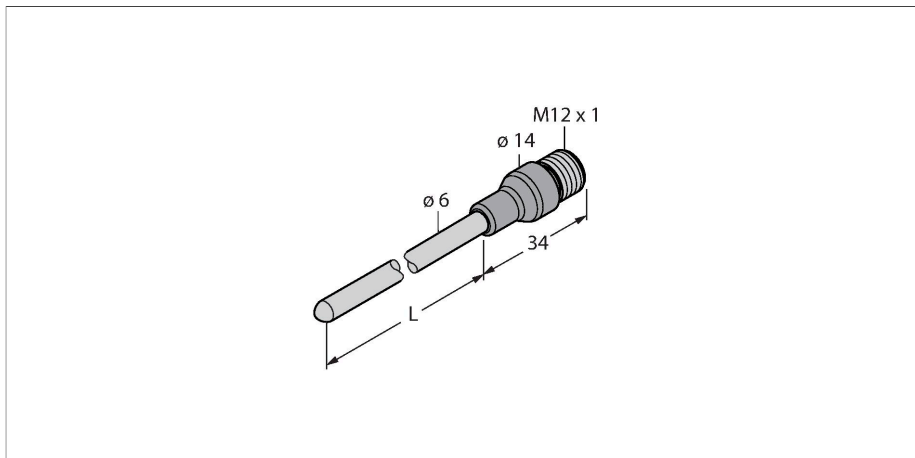

Technical data

Type	TP-206A-CF-H1141-L1000
ID	9910493
Temperature range	
Measuring range	-50...500 °C
Measuring range	-58...932 °F
Accuracy	±0.15 K + 0.002 • t (-30...300 °C)
Self-heating	0.4 K/mW at 0 °C
Measuring element	Pt-100 probe, DIN EN 60751, class A, connection mode: 4-wire connection
Response time	t 0.5 = 6 s / t 0.9 = 15 s in water at 0.2 m/s
Immersion depth (L)	1000 mm
Outer diameter	6 mm
Protection type and class	IP67
Environmental conditions	
Ambient temperature	-40...+120 °C
Storage temperature	-40...+85 °C
Mechanical data	
Housing material	Stainless steel, 1.4404 (AISI 316L)
Sensor material	Stainless steel, 1.4404 (AISI 316L)
Process connection	For compression fittings, thermowell or direct mounting
Pressure resistance	100 bar
Electrical connection	Connector, M12 × 1
Reference conditions acc. to IEC 61298-1	
Temperature	15...+25 °C
Atmospheric pressure	860...1060 hPa abs.

Features

- Pt 100 probe according to DIN EN 60751
- Resistant to vibrations and shocks
- Connectable to TS, TTM, IM34, BL20, BL67
- Max. temperature connector: 120°C
- Connection mode: 4-wire connection

Wiring diagram

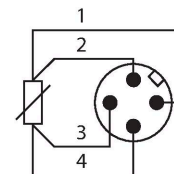

Functional principle

Resistance thermometers are used for the detection and monitoring of temperatures to optimize and control a process. Typical applications are in machine and plant construction as well as in the process industry. The core element of the temperature probe is a temperature-dependent resistor.

Technical data

Humidity	45...75 % rel.
Auxiliary power	24 VDC
Tests/approvals	
Approvals	cULus
UL registration number	E345414
MTTF	2283 years acc. to SN 29500 (Ed. 99) 20 °C

Accessories

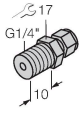
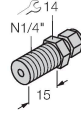
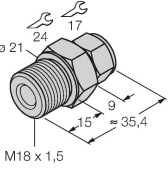
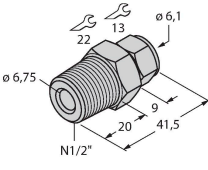
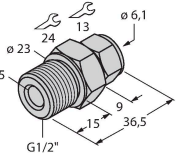
<p>CF-M-6-G1/4-A4 9910483</p> <p>Compression fitting for direct mounting of temperature sensors; sensor diameter 6 mm; process connection G1/4" male thread</p> 	<p>CF-M-6-N1/4-A4 9910484</p> <p>Compression fitting for direct mounting of temperature sensors; sensor diameter 6 mm; process connection 1/4" NPT male thread</p> 
<p>CF-M-6-M18-A4 9910525</p> <p>Compression fitting for direct mounting of temperature sensors; sensor diameter 6 mm; process connection M18 x 1 male thread</p> 	<p>CF-M-6-N1/2-A4 9910529</p> <p>Compression fitting for direct mounting of temperature sensors; sensor diameter 6 mm; process connection 1/2" NPT male thread</p> 
<p>CF-M-6-G1/2-A4 9910530</p> <p>Compression fitting for direct mounting of temperature sensors; sensor diameter 6 mm; process connection G1/2" male thread</p> 	

Accessories

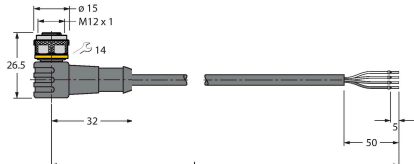
Dimension drawing	Type	ID	
	WKC4.4T-2/TEL	6625025	Connection cable, M12 female connector, angled, 4-pin, cable length: 2 m, jacket material: PVC, black; cULus approval

Dimension drawing	Type	ID	
	RKC4.4T-2/TEL	6625013	Connection cable, M12 female connector, straight, 4-pin, cable length: 2 m, jacket material: PVC, black; cULus approval
	RKC4.4T-2/TXL	6625503	Connection cable, M12 female connector, straight, 4-pin, cable length: 2 m, jacket material: PUR, black; cULus approval
	WKC4.4T-2/TXL	6625515	Connection cable, M12 female connector, angled, 4-pin, cable length: 2 m, jacket material: PUR, black; cULus approval