

TTM150C-206A-CF-LI6-H1140-L200

Temperature Detection – With Current Output

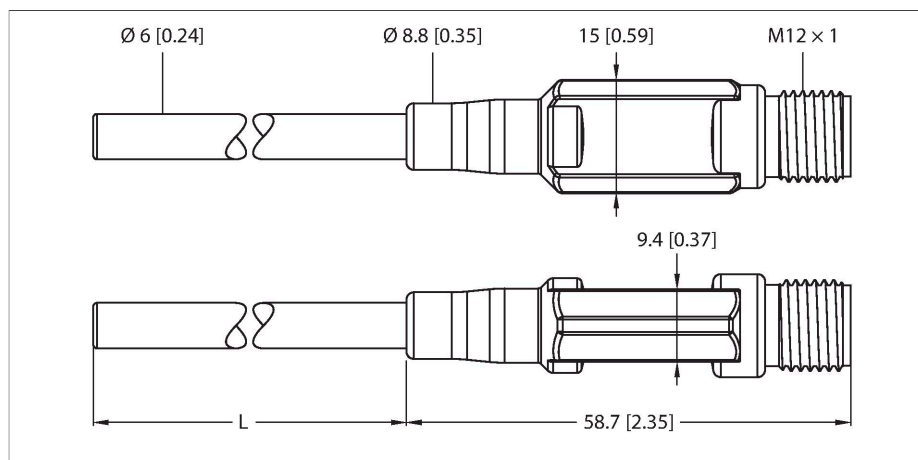

Features

- Miniature design
- Analog output 4...20 mA
- Compression fitting process connection
- Bendable probe (min. bending radius: 3x outer diameter; excluding 30-mm probe tip)

Wiring diagram

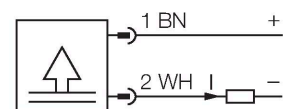

Technical data

Type	TTM150C-206A-CF-LI6-H1140-L200
ID	9910560
Temperature range	
Measuring range	0...150 °C
Measuring range	32...302 °F
Factory setting	0...150 °C
	32...302 °F
Note	Max. temperature of electronics: 80 °C/176 °F
Measuring element	Pt-1000 probe, DIN EN 60751, class A
Response time	$t_{05} = 1.5 \text{ s} / t_{09} = 6.0 \text{ s}$ in water @ 0.2 m/s
Immersion depth (L)	200 mm
Outer diameter	6 mm
Power supply	
Operating voltage	5.5...32 VDC
Current consumption	≤ 20 mA
Short-circuit/reverse polarity protection	yes / yes
Protection type and class	IP67 / III
Analog output	
Current output	4...20 mA
Load	≤ 0.84 kΩ @24 0.84 kΩ @24 VDC [$R_{\text{Load}} = (V_{\text{Supply}} - 5.5 \text{ V}) / 22 \text{ mA}$] kΩ
Accuracy (Lin. + Hys. + Rep.)	± 0.2 K
Temperature behaviour	
Temperature coefficient zero point TK_0	± 0.1 % of full scale/10 K
Temperature coefficient range TK_s	± 0.1 % of full scale/10 K

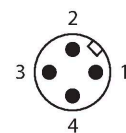

Functional principle

The TTM miniature transmitters are available with integrated probe. Due to the integrated electronics, the limited temperature range must be observed, especially in the area of the M12 connector.

Technical data

Environmental conditions	
Ambient temperature	-40...+80 °C
Storage temperature	-40...+80 °C
Mechanical data	
Housing material	Stainless-steel/Plastic, 1.4404 (AISI 316L)
Sensor material	Stainless steel, 1.4404 (AISI 316L)
Process connection	For compression fittings, thermowell or direct mounting
Pressure resistance	100 bar
Electrical connection	Connector, M12 × 1
Reference conditions acc. to IEC 61298-1	
Temperature	15...+25 °C
Atmospheric pressure	860...1060 hPa abs.
Humidity	45...75 % rel.
Auxiliary power	24 VDC
Tests/approvals	
MTTF	162 years acc. to SN 29500 (Ed. 99) 40 °C

Accessories

Dimension drawing	Type	ID	
	WKC4.4T-2/TEL	6625025	Connection cable, M12 female connector, angled, 4-pin, cable length: 2 m, jacket material: PVC, black; cULus approval
	RKC4.4T-2/TEL	6625013	Connection cable, M12 female connector, straight, 4-pin, cable length: 2 m, jacket material: PVC, black; cULus approval
	RKC4.4T-2/TXL	6625503	Connection cable, M12 female connector, straight, 4-pin, cable length: 2 m, jacket material: PUR, black; cULus approval

Dimension drawing	Type	ID	
	WKC4.4T-2/TXL	6625515	Connection cable, M12 female connector, angled, 4-pin, cable length: 2 m, jacket material: PUR, black; cULus approval
	RKC4.4T-P7X2-10/TXL	6626184	Connection cable, M12 female connector, straight, 4-pin, LED, cable length: 10 m, jacket material: PUR, black; cULus approval