

TP-206A-CF-H1141-L350

Temperature Detection – Probe

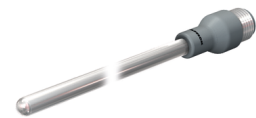
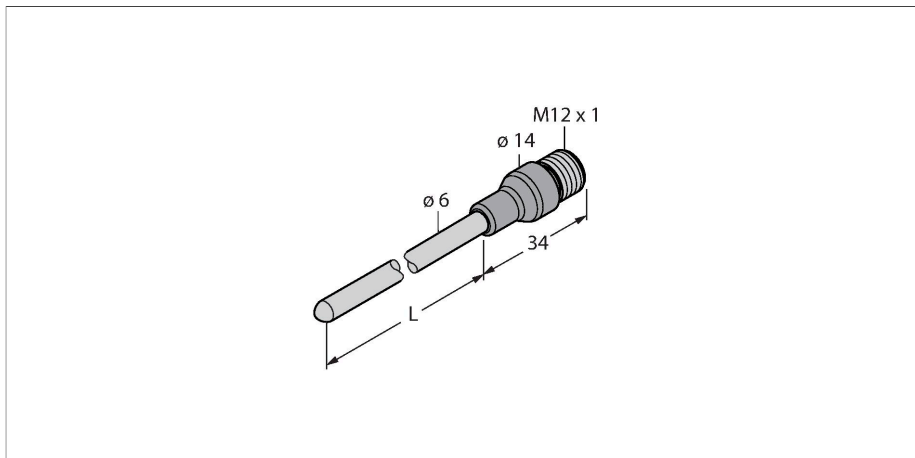

Technical data

Type	TP-206A-CF-H1141-L350
ID	9910609
Temperature range	
Measuring range	-50...500 °C
Measuring range	-58...932 °F
Accuracy	0.15 °C + 0.002 • t (-30...300 °C)
Measuring element	Pt-100 probe, DIN EN 60751, class A, connection mode: 4-wire connection
Self-heating	0.4 K/mW at 0 °C
Response time	t 0.5 = 6 s / t 0.9 = 15 s in water at 0.2 m/s
Immersion depth (L)	350 mm
Pressure resistance	100 bar
Housing material	Stainless steel, 1.4404 (AISI 316L)
Process connection	For compression fittings, thermowell or direct mounting
Electrical connection	Connector, M12 × 1
Protection class	IP67
Ambient temperature	-40...+120 °C
Storage temperature	-40...+85 °C
Tests/approvals	
UL registration number	E345414
Reference conditions acc. to IEC 61298-1	
Temperature	15...+25 °C
Atmospheric pressure	860...1060 hPa abs.
Humidity	45...75 % rel.
Auxiliary power	24 VDC

Features

- Pt100 probe according to DIN EN 60751
- Resistant to vibrations and shocks
- Can be connected to TS, TTM, IM34, BL20, BL67
- Max. temperature connector: 120°C
- Connection mode: 4-wire connection

Wiring diagram

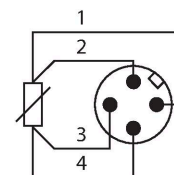

Functional principle

Resistance thermometers are used for the detection and monitoring of temperatures to optimize and control a process. Typical applications are in machine and plant construction as well as in the process industry. The core element of the temperature probe is a temperature-dependent resistor.

Technical data

MTTF	2283 years acc. to SN 29500 (Ed. 99) 20 °C
------	--

Technical data

Type	TP-206A-CF-H1141-L350
ID	9910609
Temperature range	
Measuring range	-50...500 °C
Measuring range	-58...932 °F
Accuracy	0.15 °C + 0.002 • t (-30...300 °C)
Self-heating	0.4 K/mW at 0 °C
Measuring element	Pt-100 probe, DIN EN 60751, class A, connection mode: 4-wire connection
Response time	t 0.5 = 6 s / t 0.9 = 15 s in water at 0.2 m/s
Immersion depth (L)	350 mm
Protection type and class	IP67
Ambient conditions	
Ambient temperature	-40...+120 °C
Storage temperature	-40...+85 °C
Mechanical data	
Housing material	Stainless steel, 1.4404 (AISI 316L)
Sensor material	Stainless steel, 1.4404 (AISI 316L)
Process connection	For compression fittings, thermowell or direct mounting
Pressure resistance	100 bar
Electrical connection	Connector, M12 × 1
Reference conditions acc. to IEC 61298-1	
Temperature	15...+25 °C
Atmospheric pressure	860...1060 hPa abs.
Humidity	45...75 % rel.
Auxiliary power	24 VDC
Tests/approvals	
Approvals	cULus
UL registration number	E345414
MTTF	2283 years acc. to SN 29500 (Ed. 99) 20 °C

Accessories

CF-M-6-G1/4-A4 9910483

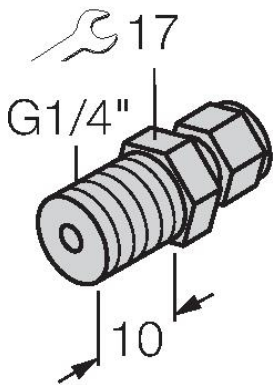

Compression fitting for direct mounting of temperature sensors; sensor diameter 6 mm; process connection G1/4" male thread

CF-M-6-N1/4-A4 9910484

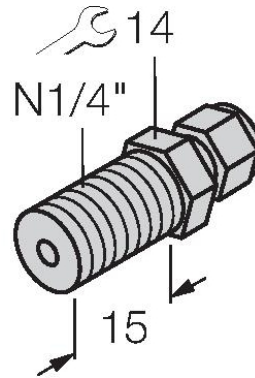

Compression fitting for direct mounting of temperature sensors; sensor diameter 6 mm; process connection 1/4" NPT male thread

CF-M-6-M18-A4 9910525

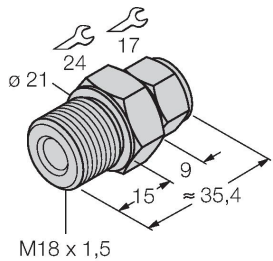

Compression fitting for direct mounting of temperature sensors; sensor diameter 6 mm; process connection M18 x 1 male thread

CF-M-6-N1/2-A4 9910529

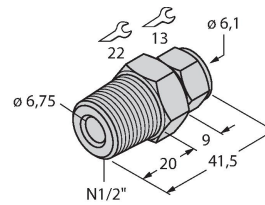

Compression fitting for direct mounting of temperature sensors; sensor diameter 6 mm; process connection 1/2" NPT male thread

CF-M-6-G1/2-A4 9910530

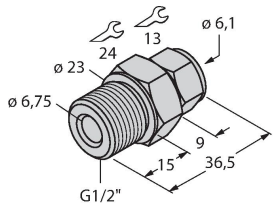

Compression fitting for direct mounting of temperature sensors; sensor diameter 6 mm; process connection G1/2" male thread

Accessories

Dimension drawing	Type	ID	
-------------------	------	----	--

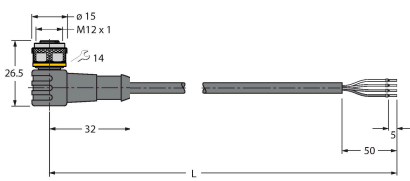

WKC4.4T-2/TEL

6625025

Connection cable, female M12, angled, 4-pin, cable length: 2 m, sheath material: PVC, black; cULus approval; other cable lengths and qualities available, see www.turck.com

RKC4.4T-2/TEL

6625013

Connection cable, female M12, straight, 4-pin, cable length: 2 m, sheath material: PVC, black; cULus approval; other cable lengths and qualities available, see www.turck.com

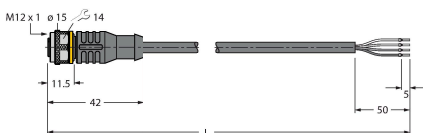

Dimension drawing	Type	ID	
	RKC4.4T-2/TXL	6625503	Connection cable, female M12, straight, 4-pin, cable length: 2 m, sheath material: PUR, black; cULus approval; other cable lengths and qualities available, see www.turck.com
	WKC4.4T-2/TXL	6625515	Connection cable, female M12, angled, 4-pin, cable length: 2 m, sheath material: PUR, black; cULus approval; other cable lengths and qualities available, see www.turck.com