

# RSS RSS 843-30M

## Industrial Ethernet Cable – Extension Cable

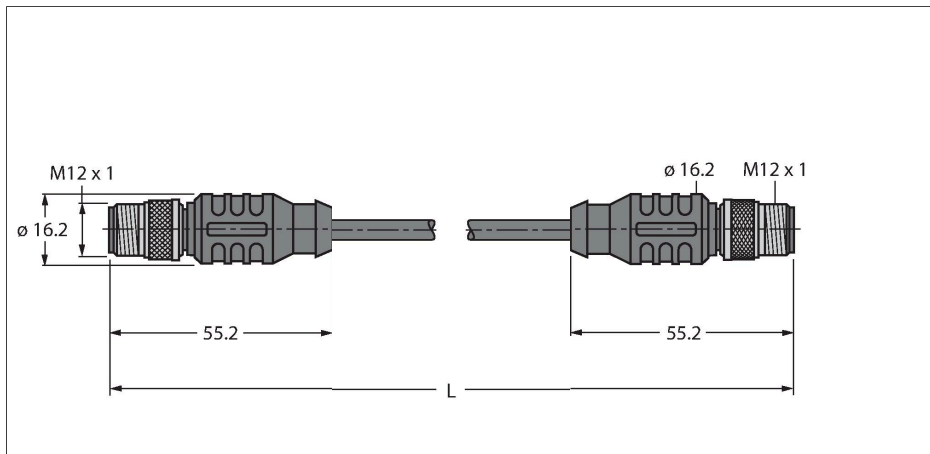

### Features

- Ethernet cable: 8-pin, AWG 24, shielded
- Jacket material: PVC, color: green
- Jacket diameter: 7.3 mm
- For permanent installation
- UL approval
- M12 male, straight, 8-pin
- M12 male, straight, 8-pin
- Cable length: 30 m

### Cable Cross-Section

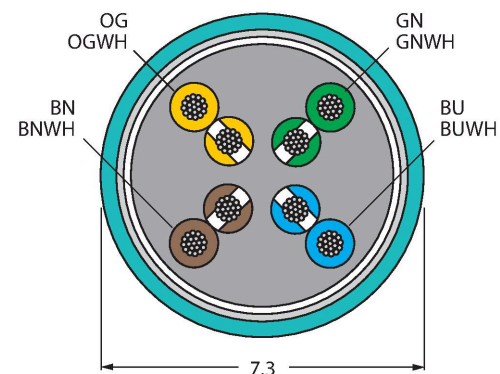

### Contact assignment

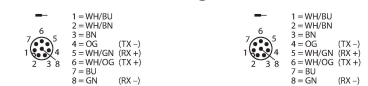

### Technical data

Type	RSS RSS 843-30M
ID	U7712-30
Connector A	Male, M12 × 1, Straight, A-coded
Number of Pins	8
Contacts	Metal, CuZn, Gold-plated
Contact carriers	Plastic, TPU, Black
Connector body	Plastic, TPU, Black
Coupling nut/screw	Brass, CuZn, Nickel-plated
Tightening torque (range)	0.8 ... 1 Nm (observe max. torque of mating connector!)
Mechanical lifespan	> 100 Mating cycles
Pollution degree	3
Protection class	IP67, Only in screwed condition
Connector B	Male, M12 × 1, Straight, A-coded
Number of pins	8
Contacts	Metal, CuZn, Gold-plated
Contact carriers	Plastic, TPU, Black
Connector body	Plastic, TPU, Blue gray
Coupling nut/retaining screw	Brass, CuZn, Nickel-plated
Tightening torque	0.8 ... 1 Nm (observe max. torque of mating connector!)
Mechanical life	> 100 Mating cycles
Pollution degree	3
Protection class	IP67, Only when screwed together
Cable	
Network protocol	Ethernet, 843
Cable diameter	Ø 7.3 mm

## Technical data

Cable length	30 m
Cable jacket	PVC, Green
Shielding	yes
Core insulation	PE
Core cross-section	8 x 0.21 mm <sup>2</sup>
<b>Electrical properties at +20 °C</b>	
Rated voltage	48 V
Current	2 A
DC resistance (loop)	94 Ω/km
Nom. impedance	100 Ω (1 MHz)
Nom. capacitance	46 pF/m
<b>Mechanical and chemical properties</b>	
Bending radius (flexible use)	≥ 7 x Ø
Bending cycles	≥ 4 million
Ambient temperature range (stationary)	-40...+80 °C
<b>Other Features</b>	
Qualified for drag chain use	no
Halogen-free	no
Approvals	UL
<b>Note</b>	
- We reserve the right to make technical modifications without prior notice.	