

RKCV RKCV 5732-25M/CS15915

Cable for RFID Application in the Food Industry – Connection Cable

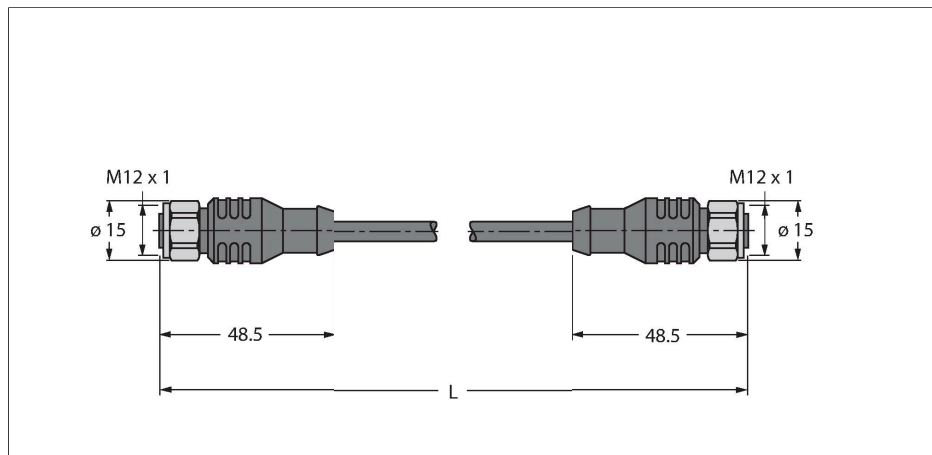

Features

- Jacket material: TPE
- Jacket color: anthracite
- Power and data pair: AWG 2/22
- M12 female, straight, stainless steel
- M12 female, straight, stainless steel

Contact assignment



Technical data

Type	RKCV RKCV 5732-25M/CS15915
ID	UX02393
Remark to product	Stranded wire color assignment equivalent to S2503
Connector A	Female, M12 × 1, Straight, A-coded
Contacts	Metal, CuZn, Gold-plated
Contact carriers	Plastic, TPU, Black
Connector body	Plastic, TPU, Black
Coupling nut/screw	Stainless Steel, V4A
Seal	Plastic, FPM/FKM
Tightening torque (range)	0.8 ... 1 Nm (observe max. torque of mating connector!)
Mechanical lifespan	> 100 Mating cycles
Pollution degree	3
Protection class	IP68, Only in screwed condition
Connector B	Female, M12 × 1, Straight, A-coded
Contacts	Metal, CuZn, Gold-plated
Contact carriers	Plastic, TPU, Black
Connector body	Plastic, TPU, Black
Coupling nut/retaining screw	Stainless Steel, V4A
Seal	Plastic, FPM/FKM
Tightening torque	0.8 ... 1 Nm (observe max. torque of mating connector!)
Mechanical life	> 100 Mating cycles
Pollution degree	3
Protection class	IP68, Only when screwed together

Technical data

Cable	
Cable diameter	Ø 8.51 mm
Cable length	25 m
Cable jacket	TPE, Anthracite
Shielding	yes
Core insulation	PE (Data), PVC (Power)
Data cable cores	
Core cross-section	2 x 0.34 mm ²
Arrangement of strands	19 x 0.15 mm
Power cable cores	
Core cross-section	2x 0.34 mm ²
Litz wire arrangement	19 x0.15 mm
Core colors	Power: RD, BK, Data: WH, BU
Electrical properties at +20 °C	
Rated voltage	250 V
Current	4 A
Mechanical and chemical properties	
Bending radius (stationary installation)	≥ 5 x Ø
Bending radius (flexible use)	≥ 15 x Ø
Ambient temperature range (stationary)	-40...+80 °C
Ambient temperature range (In motion)	-40...+80 °C
Other Features	
Qualified for drag chain use	no
Halogen-free	no