

Accesorii

Suport de montaj cu colier

Pentru cilindri fără profil sau cilindri cu tiranți

KLR1-ASB7

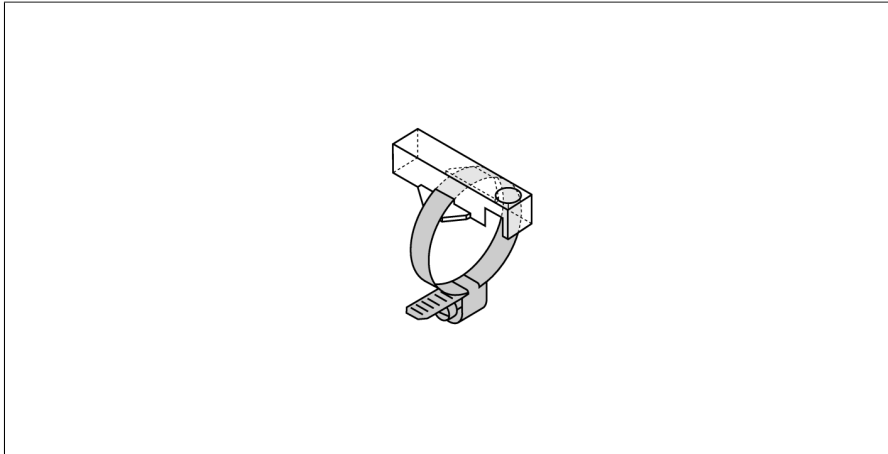

- Montare pe cilindri rotunzi
- Diametru cilindru: 64...68 mm
- Plastic: Trogamid

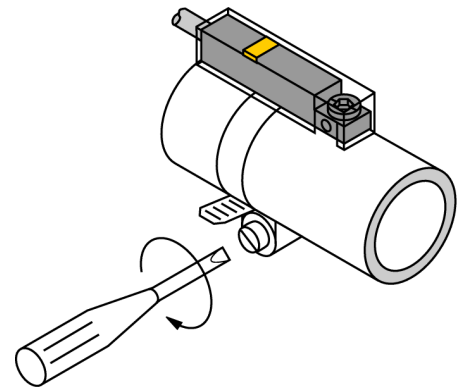

Tip	KLR1-ASB7
Nr. ID	6970606
Design	Accesorii, INT
Dimensiuni	33 x 15 x 9mm
Materialul carcasei	Plastic, Trogamid
Fixing clamp for correspondent cylinder diameter	64...68 mm