

Accesorii

Suport de montare

Pentru cilindri cu tiranți

KLI5Z

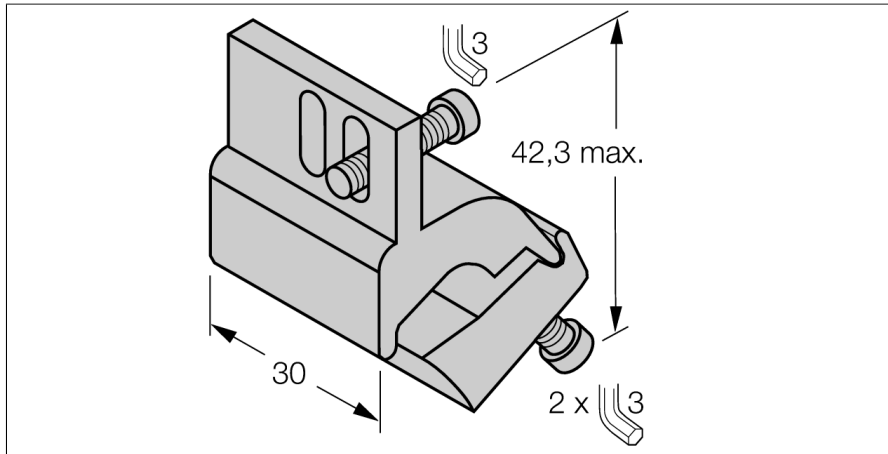

- Montare pe cilindri cu tiranți
- Diametru cilindru: 32...63 mm
- Material: Aluminu

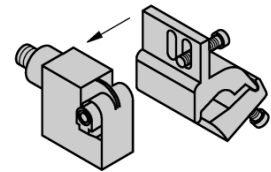
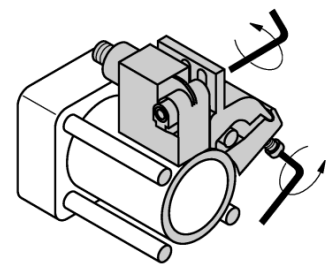

Tip	KLI5Z
Nr. ID	6971803
Design	Accesorii, IKE, IKT, IKM
Dimensiuni	42.3 x 30mm
Materialul carcasei	Metal, AL
Fixing clamp for correspondent cylinder diameter	32...63 mm
clamping width:	4... 8mm