

BL67 base module

4 × M8 Connector, 3-pin

BL67-B-4M8

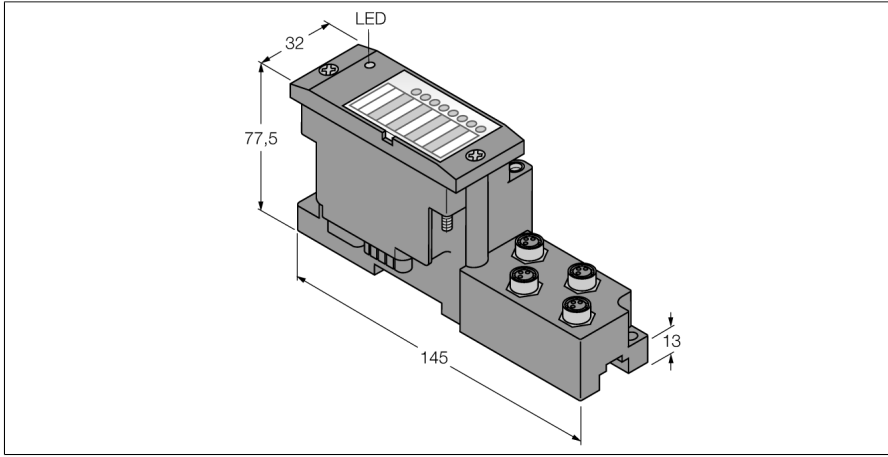

- Sensörler ve aktüatörler için pasif bağlantı bileşenleri
- Kablolulu durumda elektronik parçaların hızlı şekilde değiştirilmesi
- Mekanik kodlama, yanlış elektronik modüllerin yanlışlıkla takılmasını önler
- Koruma sınıfı IP67
- M8 connection technology
- 3-pin
- 4 slots

Kablo Bağlantı Şeması

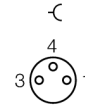

Tip	BL67-B-4M8
Tanit. no.	6827189
Housing material	Polycarbonate, flame resistance (PC V0)
Muhafaza rengi	gri (RAL 7015)
Tightening torque fixing screw	0.9...1.2 Nm
DIN rail mounting	yes, Attention: Offset
Direct mounting	Two mounting holes, 6
Pim sayısı	3

İşlevsel prensip

The pin resp. signal assignment results from the combination with an electronic module. You find the pin configuration and the wiring diagrams on the data sheet of the corresponding electronic module.

BL67 base modules are connected to the right of the gateway, using two screws for each module. A DIN rail is not required. This way, a compact and stable unit is built. The unit can now be mounted on a DIN rail or directly on the machine.

The field devices are connected to the base modules which are available with different connection technology (M8, M12, M23 and 7/8").

Note

Further technical data like temperature range are determined by the electronic modules and can be found on the data sheets.