

# BL67 electronic module

## 4 Digital Inputs, PNP, Channel Diagnostics

### BL67-4DI-PD

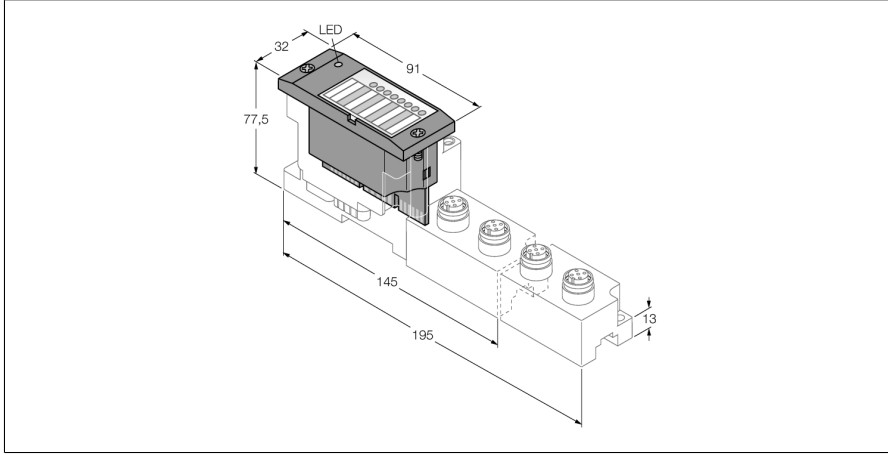

- Kullanılan fieldbus ve bağlantı teknolojisinden bağımsız
- Koruma sınıfı IP67
- LEDs indicate status and diagnostic
- Electronics galvanically separated from the field level via optocouplers
- 4 digital inputs, 24 VDC
- PNP switching
- Channel diagnostics
- Wire-break monitoring
- Adjustable filter times
- Invertible inputs

Tip	BL67-4DI-PD
Tanit. no.	6827204
Kanal sayısı	4
Besleme gerilimi	24 VDC
Nominal voltage $V_n$	24 VDC
Alan beslemesinden gelen nominal akım	$\leq 100$ mA
Modül veri yolundan gelen nominal akım	$\leq 30$ mA
Max. sensor supply $I_{sens}$	100 mA per channel, electronic short-circuit limiting
Güç dağılımı, tipik	$\leq 1.5$ W
Giriş tipi	PNP
Type of input diagnostics	channel diagnostics
Düşük seviye sinyal gerilimi	$< 4.5$ V
Yüksek seviye sinyal gerilimi	7...30 V
Düşük seviye sinyal akımı	$< 1.5$ mA
Yüksek seviye sinyal akımı	2.1...3.7 mA
Giriş gecikmesi	0.25; 2.5 ms
Elektrik yalıtımı	electronics for the field level
Çıkış bağlantısı	M8, M12, M23
Tanımlama bit sayısı	6
Parametre bayt sayısı	4







#### İşlevsel prensip

BL67 electronic modules are plugged on the purely passive base modules which in turn are connected to the field devices. The separation of connection level and electronics simplifies maintenance considerably. Flexibility is enhanced because the user can choose between base modules with different connection technologies.

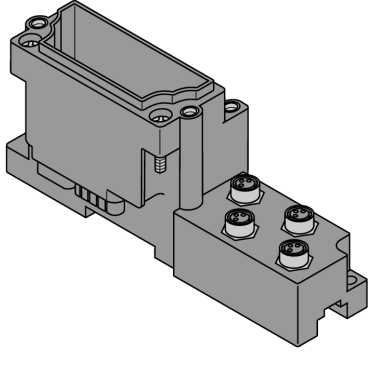
The electronic modules are completely independent of the higher level fieldbus through the use of gateways.

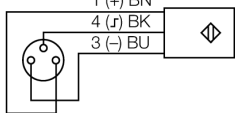
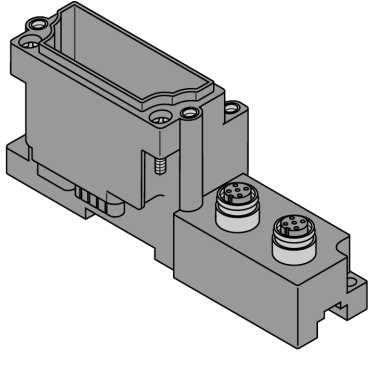
Boyutlar (W x L x H)	32 x 91 x 59 mm
Onaylar	CE
Ortam sıcaklığı	-40...+70 °C
Sıcaklık değeri kaybı	
< 0°C Ortam sıcaklığı	Support for version VN 01-03 and higher, no limitation
Saklama sıcaklığı	-40...+85 °C
Bağıl nem	%5...95 (dahili), seviye RH-2, yoğuşmasız (45°C'de depolandığında)
Titreşim testi	EN 61131 uyarınca
- up to 5 g (at 10 to 150 Hz)	for mounting on DIN rail no drilling according to EN 60715, with end bracket
- up to 20 g (at 10 up to 150 Hz)	for mounting on base plate or machinery Therefore every second module has to be mounted with two screws each.
Darbe testi	IEC 60068-2-27 uyarınca
Düşme ve devrilme	acc. to IEC 68-2-31 and free fall to IEC 68-2-32
Elektromanyetik uyumluluk	EN 61131-2 uyarınca
IP Derecesi	IP67
Tightening torque fixing screw	0.9...1.2 Nm

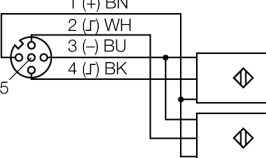
## Compatible base modules

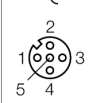
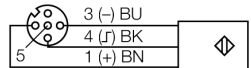
Ölçekli çizim	Type	Pin configuration
	<p><b>BL67-B-4M8</b> 6827189 4 x M8, 3-pole, female</p> <p><b>Comments</b> Bağlantı kablosunun eşleştirilmesi (örnek): PKG3M-2-PSW3M/TXL Tanım. No. 6625668</p>	<p><b>Tel ataması</b></p> <p>⌋</p>  <p>1 = V<sub>SENS</sub> 3 = GND 4 = Input A</p> <p><b>Wiring Diagram</b></p> 
	<p><b>BL67-B-2M12</b> 6827186 2 x M12, 5-pole, female, A-coded</p> <p><b>Comments</b> If the wire-break monitoring has been activated, on the sensor side a jumper between pin 1 (24 V DC) and pin 2 (diagnostics input) must be implemented for monitoring of wire-breaks. <b>Note</b> wire-break monitoring only in connection with the base module BL67-B-2M12 possible!</p> <p><b>BL67-B-2M12-P</b> 6827194 2 x M12, 5-pole, female, A-coded, paired</p> <p><b>Comments</b> If the wire-break monitoring has been activated, on the sensor side a jumper between pin 1 (24 V DC) and pin 2 (diagnostics input) must be implemented for monitoring of wire-breaks. <b>Note</b> wire-break monitoring only in connection with the base module BL67-B-2M12 possible!</p>	<p><b>Tel ataması</b></p> <p>⌋</p>  <p>1 = V<sub>SENS</sub> 2 = Input B 3 = GND 4 = Input A 5 = PE</p> <p><b>Wiring Diagram</b></p> 
	<p><b>BL67-B-4M12</b> 6827187 4 x M12, 5-pole, female, A-coded</p> <p><b>Comments</b> Bağlantı kablosunun eşleştirilmesi (örnek): RKC4.4T-2-RSC4.4T/TXL Tanım. No. 6625608</p>	<p><b>Tel ataması</b></p> <p>⌋</p>  <p>1 = V<sub>SENS</sub> 2 = n.c. 3 = GND 4 = Input A 5 = PE</p> <p><b>Wiring Diagram</b></p> 

**LED display**

LED	Color	Status	Meaning
D		OFF	No error message or diagnostics active.
	RED	ON	Failure of module bus communication. Check if more than 2 adjacent electronic modules are pulled. Relevant modules are located between gateway and this module.
	RED	FLASHING (0.5 Hz)	Upcoming module diagnostics
DI channels 0...3		OFF	Status input x = 0 (OFF), no active diagnostics
	GREEN	ON	Input status x = 1 (ON)
	RED	ON	Wire-break monitoring active (LED 0 and 1)
	RED	FLASHING (2 Hz)	Overload sensor supply

**Note:**

The numbering of the LEDs corresponds to the numbering of the channels.

## Data mapping

DATA	BYTE	Bit 7	Bit 6	Bit 5	Bit 4	Bit 3	Bit 2	Bit 1	Bit 0
Input	n	-	-	-	-	DI 3	DI 2	DI 1	DI 0

n = Offset of input data; depending on extension of station and the corresponding fieldbus.

m = Offset of output data; depending on extension of station and the corresponding fieldbus.

With PROFIBUS, PROFINET and CANopen, the I/O data of this module is localized within the process data of the whole station via the hardware configuration tool of the fieldbus master.

With DeviceNet™, EtherNet/IP™ and Modbus TCP a detailed mapping table can be created with the TURCK configuration tool I/O-ASSISTANT.

## Pin assignment at corresponding base module:

DATA	BYTE	Bit 7	Bit 6	Bit 5	Bit 4	Bit 3	Bit 2	Bit 1	Bit 0
------	------	-------	-------	-------	-------	-------	-------	-------	-------

<b>BL67-B-4M8</b>									
Input	n	-	-	-	-	C3 P4	C2 P4	C1 P4	C0 P4
<b>BL67-B-2M12</b>									
Input	n	-	-	-	-	C1 P2	C0 P2	C1 P4	C0 P4
<b>BL67-B-2M12-P</b>									
Input	n	-	-	-	-	C1 P2	C1 P4	C0 P2	C0 P4
<b>BL67-B-4M12</b>									
Input	n	-	-	-	-	C3 P4	C2 P4	C1 P4	C0 P4

C... = slot no., P... = pin no.