

P9-RI-QR24

Accessories – Positioning Element For Encoders RI-QR24

Features

- Positioning element, for Ø 1/2" shafts

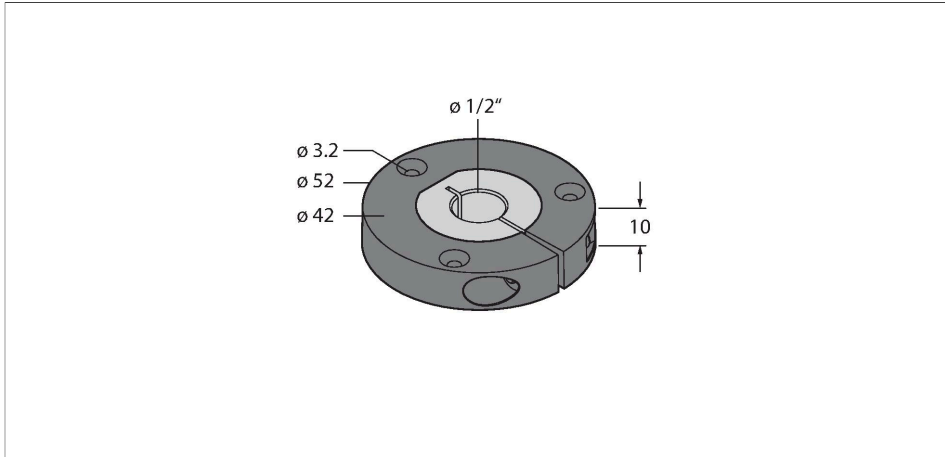

Technical data

Type	P9-RI-QR24
Ident. no.	1593012
Housing material	Metal/plastic